

The Kingston Box, Kingston, Ontario

Solar Facade - Case Study

Project Overview

The Kingston Box is a Solar Facade project on the penthouse of a Kingston, Ontario building. This project incorporates active and non-active modules in the four orientations (South, West, East, and North) and features a brown pixelated color. In addition, the modules located at the bottom of the building are non-solar cladding (white color panels).

Project Information

Total Project Area: 1,323 SQFT
 Active Area: 957 SQFT
 Non-Active Area: 223.75 SQFT
 Non-Solar Cladding Area: 142.25 SQFT

The table below shows the active, non-active and non-solar cladding area (SQFT) of each building's orientation.

Orientation	Non-Solar Cladding	Mitrex Active Modules	Mitrex Non-Active Modules	Total
East	42.25	326.25	46.75	415.25
South	20.5	130.5	94.5	245.5
West	52.75	348	18.75	419.5
North	26.75	152.25	63.75	242.75



Mitrex solar module used for this project is:

Module Code	Pmax (W)	Voc (V)	Isc (A)	Vmp (V)	Imp (A)	Tolerance (%)
M265-SD08F612	265	48.4	6.84	40.5	6.55	+/- 5

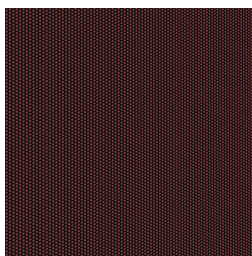

⚡ Brown-1217S
Solar Solid Colors

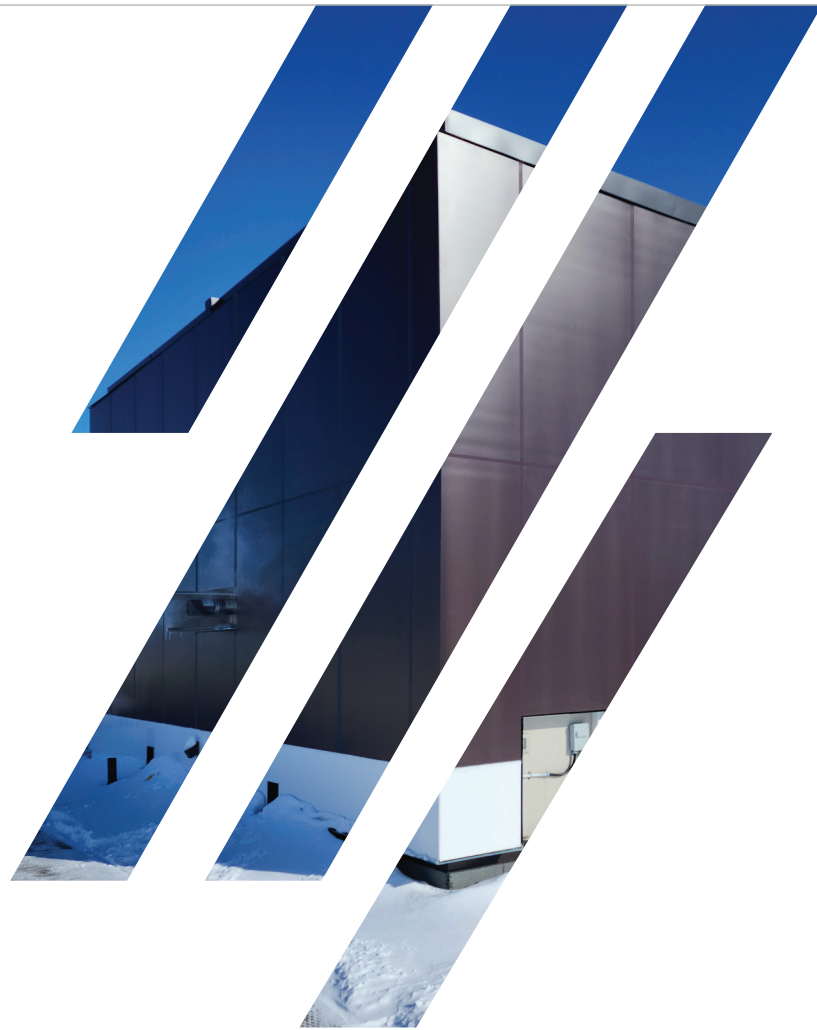

Please note that the orientation of South facing modules is 21 degree to the East and all other orientations are based on this 21 degree shift. A total of 44 modules (of M265-SD08F612) were installed in this project:

- 6 panels are facing South
- 16 panels are facing West
- 15 panels are facing East
- 7 panels are facing North.

Solaredge SE9KUS (9 kW) with 44 S440 optimizer have been used to convert the energy production from Mitrex modules to 208V AC usable by the building.

Two strings of 22 optimizers are used for this project.

One string has 6 panels of South and 16 panels of West, while the second has 7 panels of North and 15 panels of East orientation.

Solaredge designer tool has been used to estimate the generation of this project. Annual energy production after inverter and optimizer losses is 6.91 MWh. Here is the estimated monthly generation:

Comparative Table Between Estimated Power VS Actual Power

Month	Jan	Feb	Mar	Apr	May	Jun	Jul	Aug	Sep	Oct	Nov	Dec
Estimation (kWh)	316	424	627	679	837	821	779	747	637	453	302	286
Actual (kWh)	333	457	668	479	976	759	882	782	784	418	242	216

Comparative Graphic Between Estimated Power Vs Actual Power

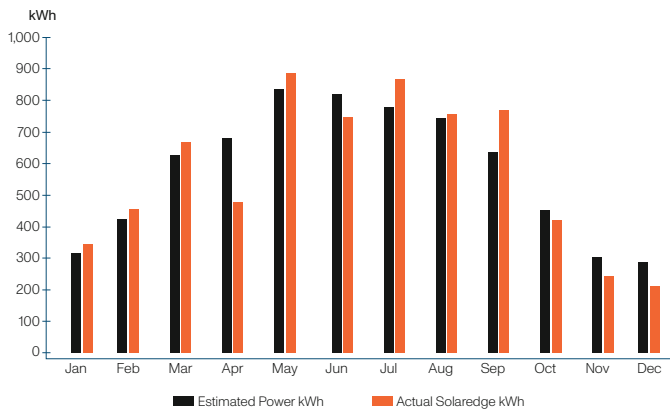

Since the total DC size of system is 11.66 kW, specific production (Performance index) of this project is 593 kWh/KWp/Year (Equal to 593 hours).

The project was completed on February 1st, 2023, and was ON for testing and commissioning. From April 19th till May 1st, 2023, the system was off and was ready for Hydro to do the final connection.

The monitoring of this project is available through Solaredge monitoring website or app. To access it, please use the following credentials:

Username: info@mitrex.com
 Password: Mitrex2023
 Link to Access: monitoring.solaredge.com

From the monitoring of the project, up to November 20th 2023, the production is as below:

Solaredge Energy Generation Monitoring

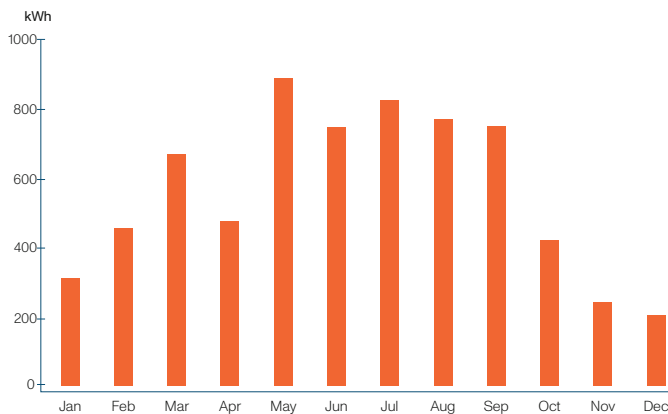

Modules Layout Per Elevation

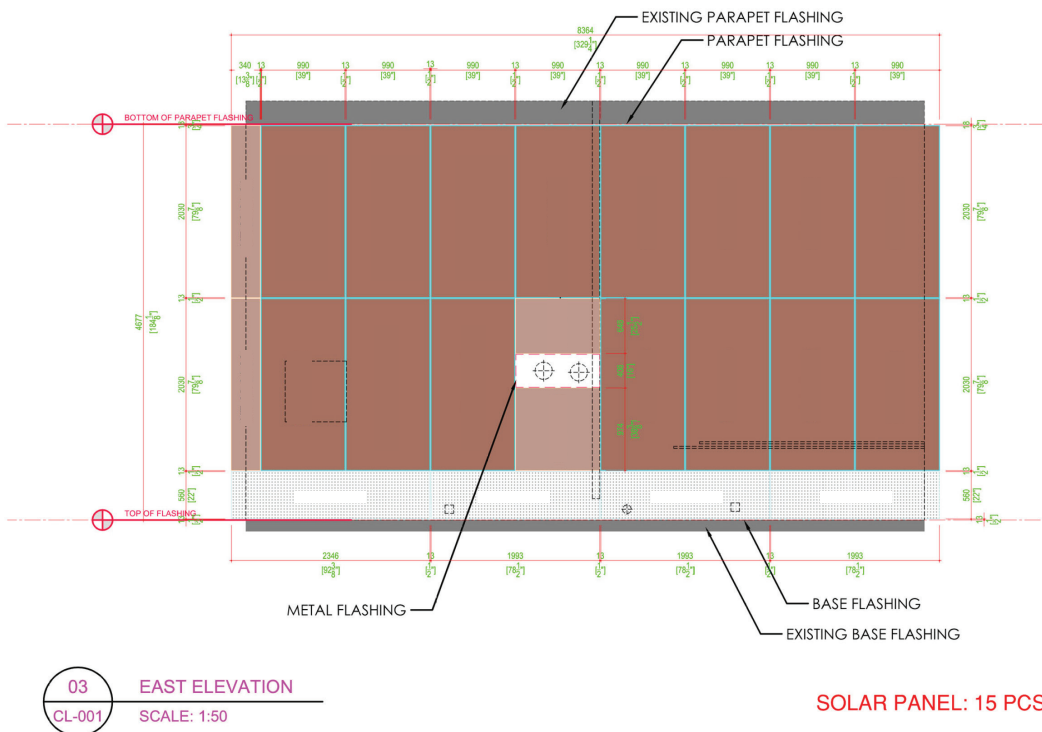
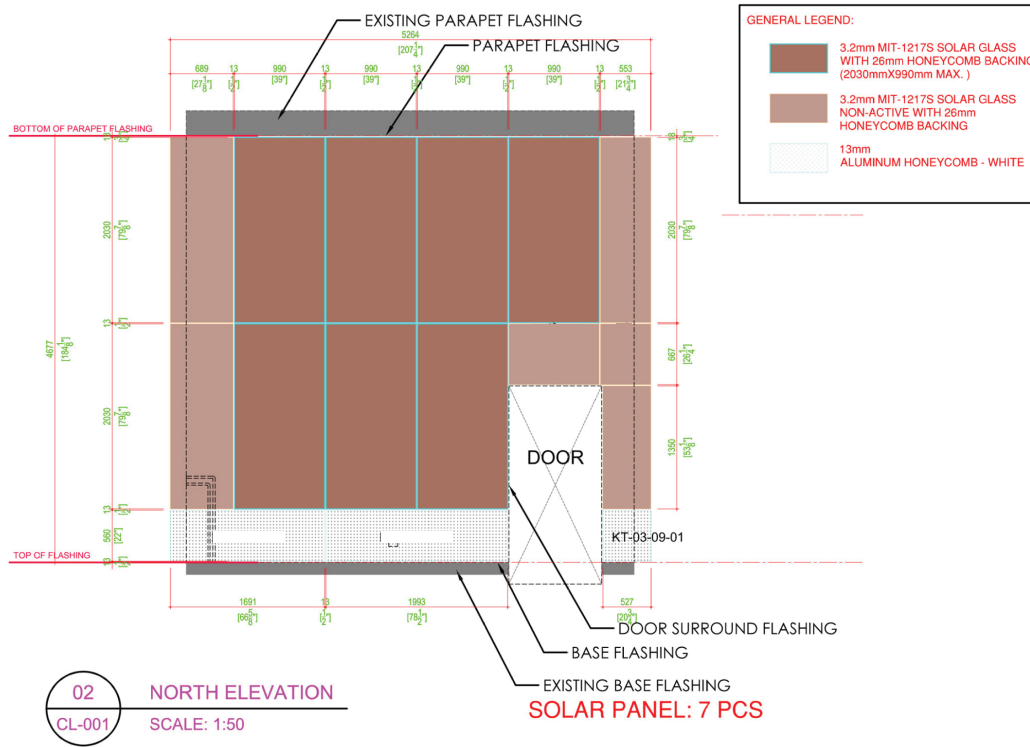

Modules Layout Per Elevation

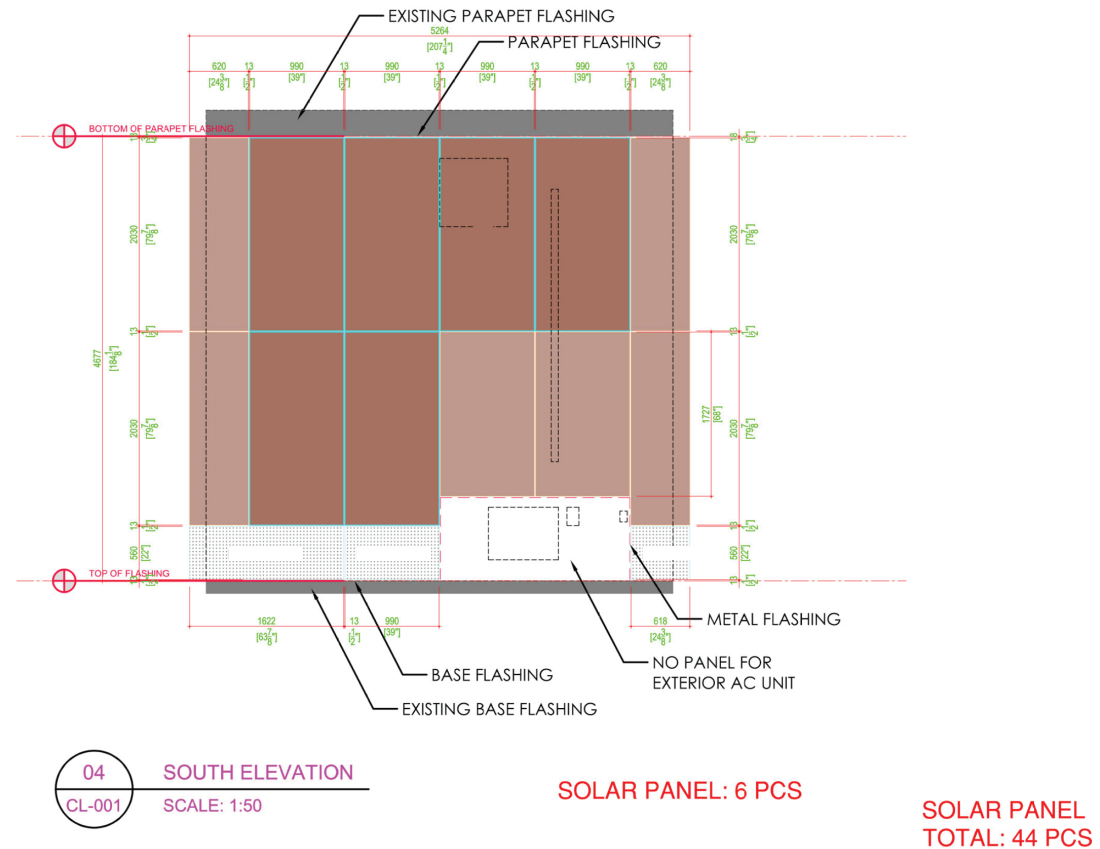
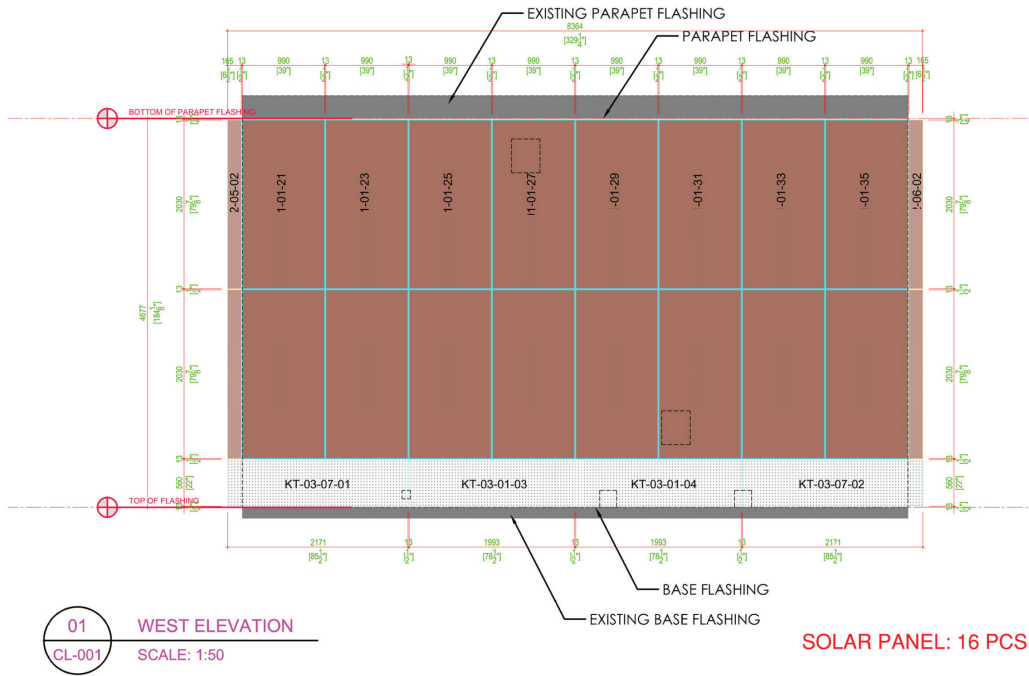

Electrical Connections Per Elevation

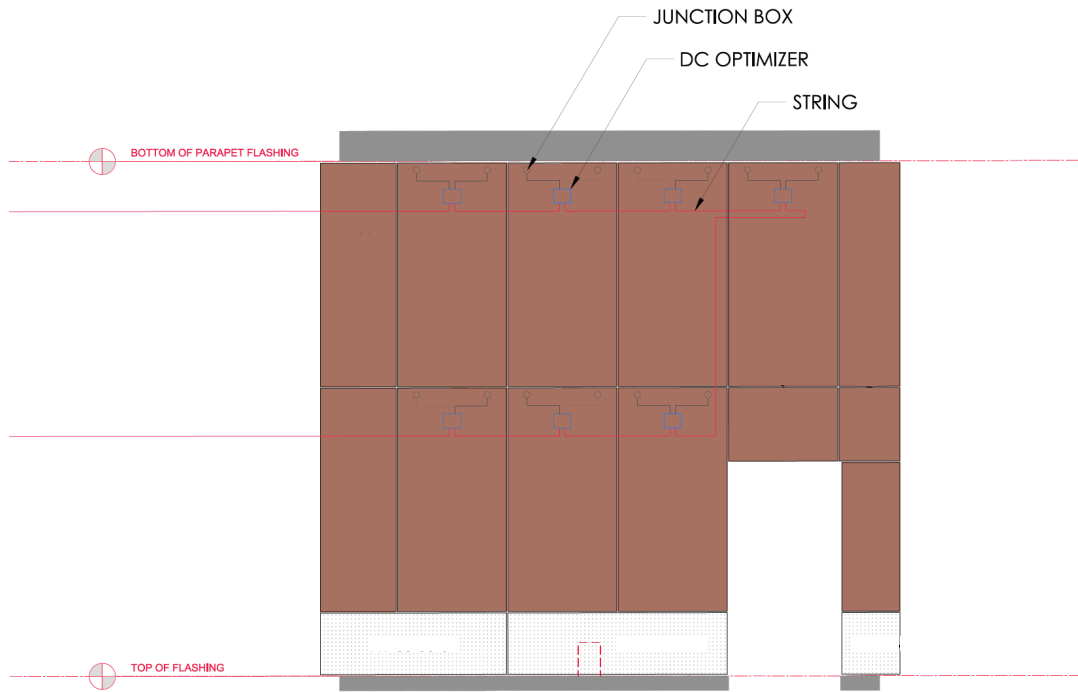

02 NORTH ELEVATION
CL-001 SCALE: 1:50

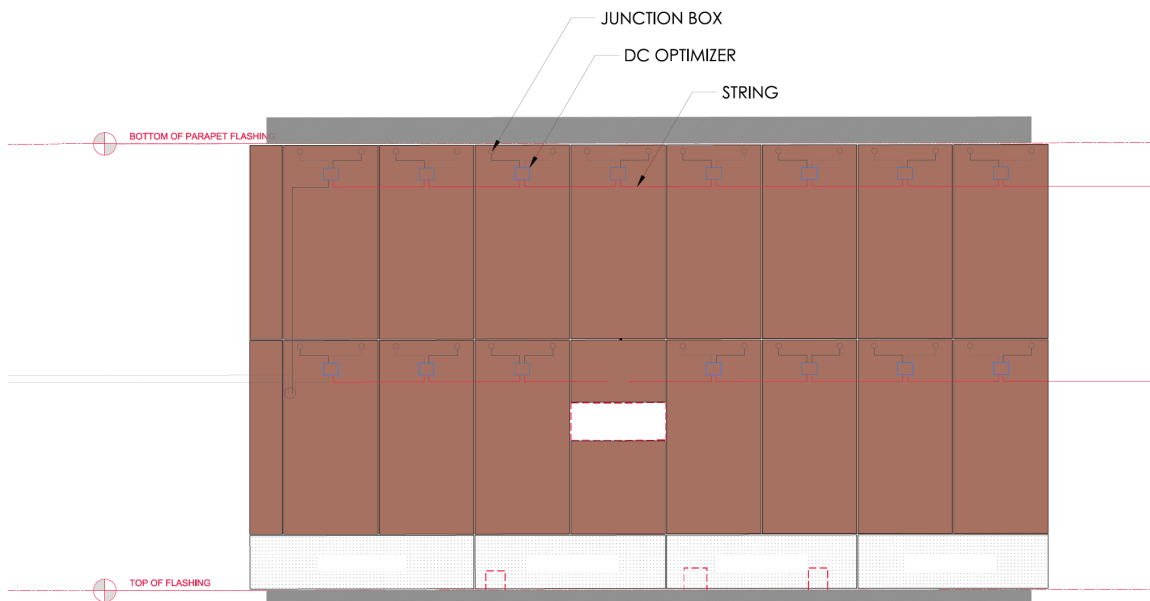

03 EAST ELEVATION
CL-001 SCALE: 1:50

Electrical Connections Per Elevation

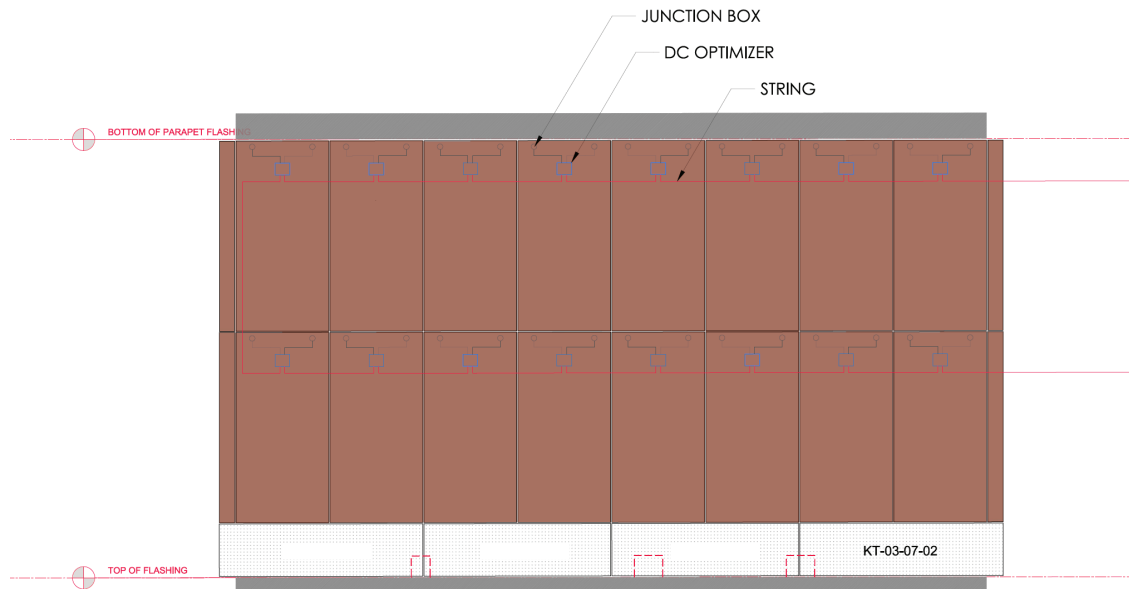

01 WEST ELEVATION
CL-001 SCALE: 1:50

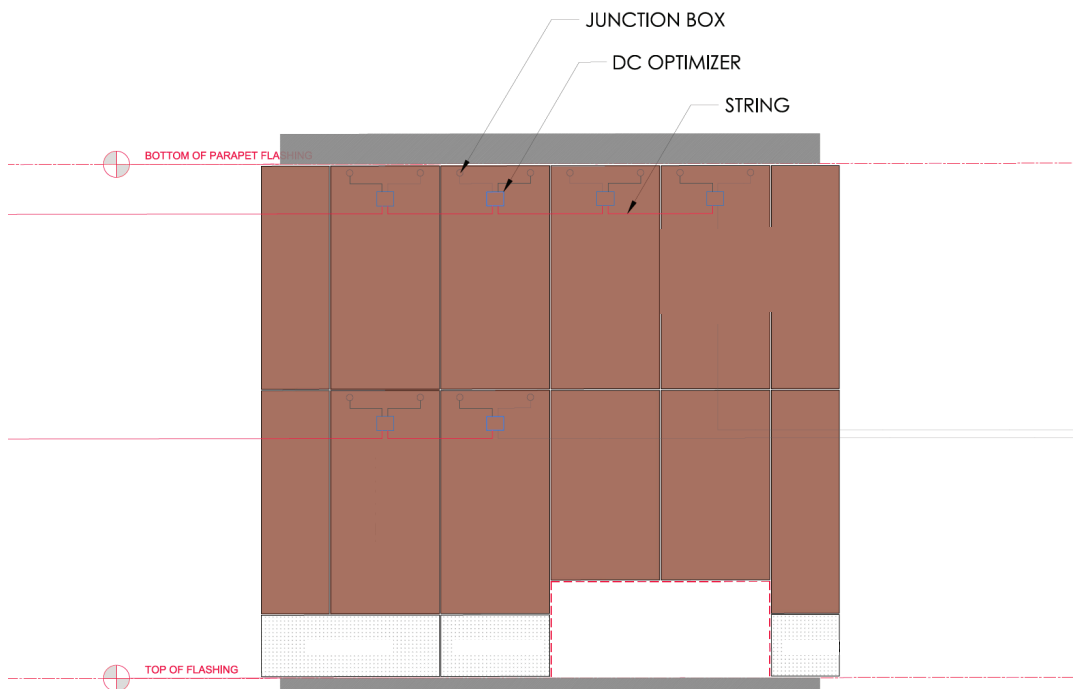

04 SOUTH ELEVATION
CL-001 SCALE: 1:50

Brown-1217S - 265W

High Efficiency Mono Colored PV Module

- **North American Manufacturer**

Mitrex is a world-leading manufacturer of standard solar and BIPV products based in Canada. With over 20 years of experience, Mitrex guarantees high-quality, fully-automated manufacturing and continuous innovation in solar technology.

- **Quality, Durability And Performance**

Mitrex panels are engineered with the highest quality- featuring wide-ranging compatibility with racking and electrical components, advanced cell technology, ability to withstand high snow/wind load conditions, and high performing modules.

- **25-Year Product And Performance Warranty**

Made in North America, all our products come with an industry leading 25-year warranty for products and performance, ensuring the quality of the hardware, energy generation, and aesthetics are maintained.

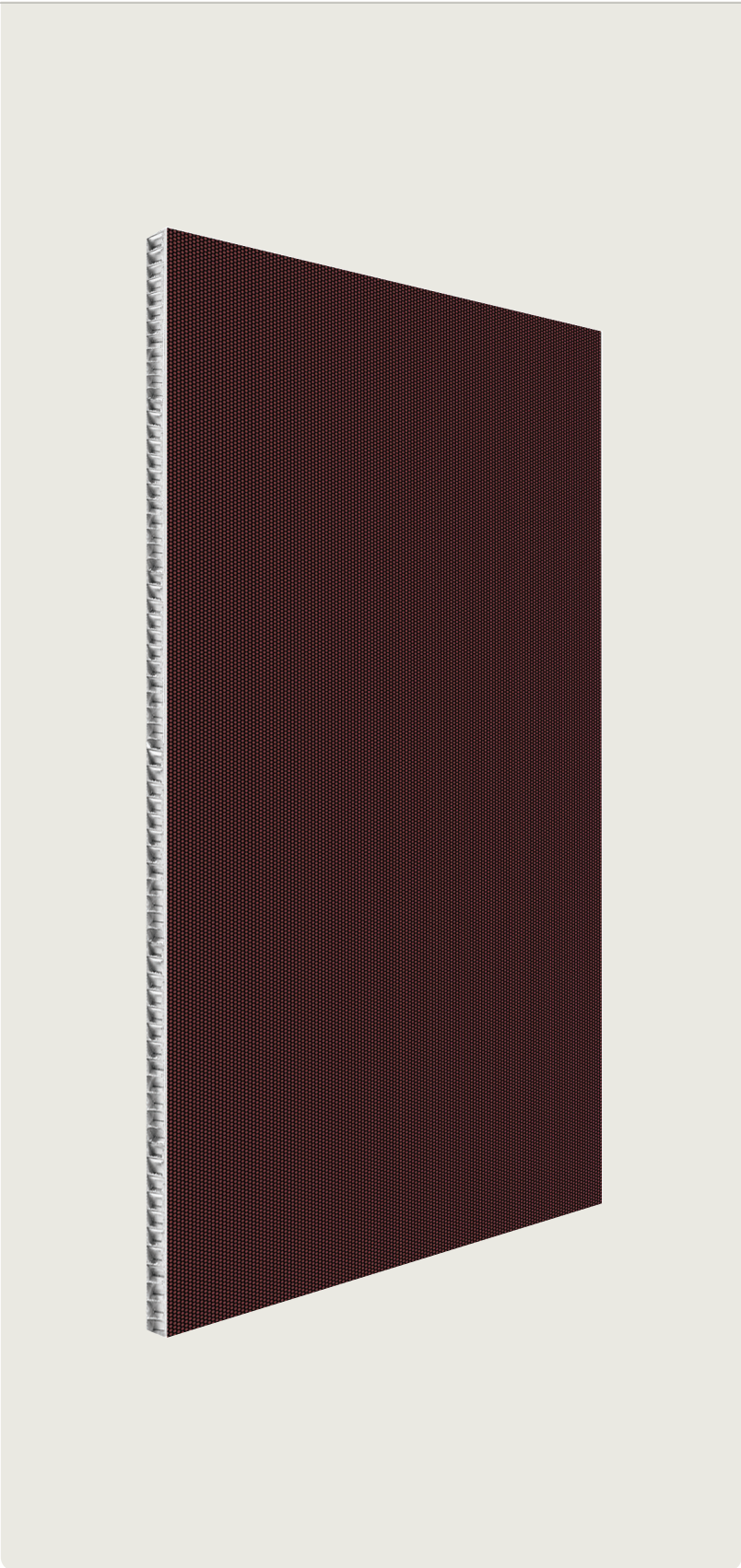

Electrical Specifications

Test Conditions	STC
Module Power (Pmax)	265W
Maximum Power Voltage (Vpmax)	40.5V
Maximum Power Current (Ipmax)	6.55A
Open Circuit Voltage (Voc)	48.4V
Short Circuit Current (Isc)	6.84A
Module Efficiency	13.2%
Maximum System Voltage (VDC)	1000V (IEC/UL)
Series Fuse Rating	20A
Power & Other Electrical Specification Tolerance	5%

Application Classification Class A

Measurement Conditions: STC 1000 W/m² - AM 1.5 - Temperature 25°C

Engineering Drawing

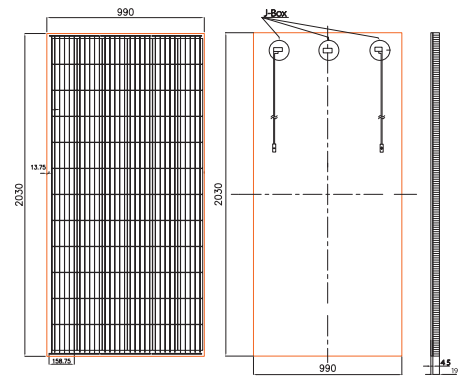

Mechanical Properties

Module Weight	29 kg
Dimensions (H x L x D)	2030 × 990 × 30mm
Maximum Surface Load (Wind / Snow)	2400Pa rear load / 2400Pa front load
Hail Impact Resistance	ø 25mm at 83 km/h
Cells	72 [12×6] Mono-crystalline (158.75 × 158.75mm)
Glass	3.2mm tempered glass, high transmittance, anti-reflective coating
Cables & Connectors	300mm, 500mm, 1000mm, 1200mm - 4mm ² , 12 AWG (UL), MC4 from Staubli
Backsheet	High durability, UV resistant, PV backsheet
Back Support	Aluminum Honeycomb
Bypass Diodes	3 diodes- 30SQ045T (45V max DC blocking voltage, 30A max forward rectified current)
Junction Box	IP68 rated, TUV and UL certified
Fire Rating	Spread of flame A and C burning brand.

Metric

Module Weight	29 kg
Dimensions (H x L x D)	2030 × 990 × 30mm
Maximum Surface Load (Wind / Snow)	2400Pa rear load / 2400Pa front load
Hail Impact Resistance	ø 25mm at 83 km/h
Cells	72 [12×6] Mono-crystalline (158.75 × 158.75mm)
Glass	3.2mm tempered glass, high transmittance, anti-reflective coating
Cables & Connectors	300mm, 500mm, 1000mm, 1200mm - 4mm ² , 12 AWG (UL), MC4 from Staubli
Backsheet	High durability, UV resistant, PV backsheet
Back Support	Aluminum Honeycomb
Bypass Diodes	3 diodes- 30SQ045T (45V max DC blocking voltage, 30A max forward rectified current)
Junction Box	IP68 rated, TUV and UL certified
Fire Rating	Spread of flame A and C burning brand.

Imperial

Module Weight	63.9 lbs
Dimensions (H x L x D)	79.9 × 39.0 × 1.18in
Maximum Surface Load (Wind / Snow)	50.1psf rear load / 50.1psf front load
Hail Impact Resistance	ø 1in at 51.6 mph
Cells	72 [12×6] Mono-crystalline (6.25 × 6.25in)
Glass	0.126in tempered glass, high transmittance, anti-reflective coating
Cables & Connectors	11.8in, 19.7in, 39.4in, 47.2in - 0.16in ² , 12 AWG (UL) MC4 from Staubli
Backsheet	High durability, UV resistant, PV backsheet
Back Support	Aluminum Honeycomb
Bypass Diodes	3 diodes- 30SQ045T (45V max DC blocking voltage, 30A max forward rectified current)
Junction Box	IP68 rated, TUV and UL certified
Fire Rating	Spread of flame A and C burning brand.

Temperature Ratings

Temperature Coefficient Isc	0.036% /°C
Temperature Coefficient Voc	-0.27% /°C
Temperature Coefficient Pmax	-0.36% /°C
Nominal Module Operating Temperature	42 ± 3°C
Operating Temperature	-40°C ~ +85°C

Warranty

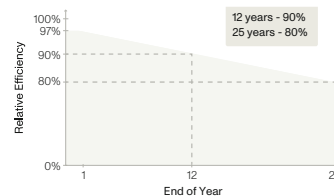

Product Material Warranty: 25 years
 Performance Warranty: 25 years
 ≥ 97% end of 1st year
 ≥ 90% end of 12th year
 ≥ 80% end of 25th year

I-V Curves

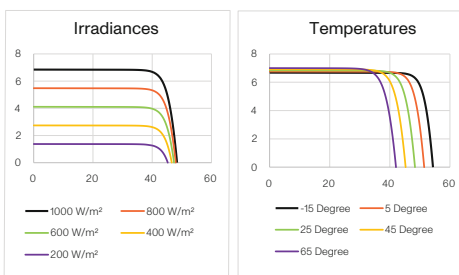

Certifications

- UL 61730-1/-2
- CSA C22.2 #61730-1/-2
- IEC 61730-1/-2

Datasheet is subjected to change without prior notice, always obtain the most recent version of the datasheet. **Caution:** For professional use only, the installation, handling, and cleaning of PV modules should only be performed by qualified professionals. Read the Installation Manual for mounting specifications before handling, installing and operating modules.

Power Optimizer

For North America

S440



POWER OPTIMIZER

PV power optimization at the module level

- Specifically designed to work with SolarEdge residential inverters
- Detects abnormal PV connector behavior, preventing potential safety issues*
- Module-level voltage shutdown for installer and firefighter safety
- Superior efficiency (99.5%)
- Mitigates all types of module mismatch loss, from manufacturing tolerance to partial shading
- Faster installations with simplified cable management and easy assembly using a single bolt
- Flexible system design for maximum space utilization
- Compatible with bifacial PV modules
- Meets NEC requirements for arc fault protection (AFCI) and Photovoltaic Rapid Shutdown System (PVRSS)

* Functionality subject to inverter model and firmware version

solaredge.com

solaredge

/ Power Optimizer

For North America

S440

		S440	Unit
INPUT			
Rated Input DC Power ⁽¹⁾		440	W
Absolute Maximum Input Voltage (Voc)		60	Vdc
MPPT Operating Range		8 - 60	Vdc
Maximum Short Circuit Current (Isc) of Connected PV Module		14.5	Adc
Maximum Efficiency		99.5	%
Weighted Efficiency		98.6	%
Overvoltage Category		II	
OUTPUT DURING OPERATION			
Maximum Output Current		15	Adc
Maximum Output Voltage		60	Vdc
OUTPUT DURING STANDBY (POWER OPTIMIZER DISCONNECTED FROM INVERTER OR INVERTER OFF)			
Safety Output Voltage per Power Optimizer		1	Vdc
STANDARD COMPLIANCE			
Photovoltaic Rapid Shutdown System		NEC 2014, 2017 & 2020	
EMC		FCC Part 15 Class B, IEC61000-6-2, IEC61000-6-3	
Safety		IEC62109-1 (class II safety), UL1741	
Material		UL94 V-0, UV Resistant	
RoHS		Yes	
Fire Safety		VDE-AR-E 2100-712:2013-05	
INSTALLATION SPECIFICATIONS			
Maximum Allowed System Voltage		1000	Vdc
Dimensions (W x L x H)		129 x 155 x 30 / 5.07 x 6.10 x 1.18	mm / in
Weight (including cables)		655 / 1.5	gr / lb
Input Connector		MC4 ⁽²⁾	
Input Wire Length		0.1 / 0.32	m / ft
Output Connector		MC4	
Output Wire Length		(+) 2.3, (-) 0.10 / (+) 7.54, (-) 0.32	m / ft
Operating Temperature Range ⁽³⁾		-40 to +85	°C
Protection Rating		IP68 / NEMA6P	
Relative Humidity		0 - 100	%

- (1) Rated power of the module at STC will not exceed the Power Optimizer Rated Input DC Power. Modules with up to +5% power tolerance are allowed
 (2) For other connector types please contact SolarEdge
 (3) For ambient temperature above +70°C / +158°F power de-rating is applied. Refer to Power Optimizers Temperature [De-Rating Technical Note](#) for more details

PV System Design Using a SolarEdge Inverter		Single Phase HD-Wave	Three Phase 208V Grid	Three Phase for 277/480V Grid	
Minimum String Length (Power Optimizers)	S440	8	10	18	
Maximum String Length (Power Optimizers)		25		50 ⁽⁴⁾	
Maximum Nominal Power per String ⁽⁵⁾		5700 (6000 with SE7600-US - SE11400-US)	6000 ⁽⁶⁾	12750 ⁽⁷⁾	W
Parallel Strings of Different Lengths or Orientations		Yes			

- (4) A string with more than 30 optimizers does not meet NEC rapid shutdown requirements; safety voltage will be above the 30V requirement
 (5) If the inverters rated AC power ≤ maximum nominal power per string, then the maximum power per string will be able to reach up to the inverters maximum input DC power
 Refer to: <https://www.solaredge.com/sites/default/files/se-power-optimizer-single-string-design-application-note.pdf>
 (6) For the 208V grid: it is allowed to install up to 7,800W per string, two minimum string count are required and up to 7,200W without minimum string count. The maximum power difference between each string is 1,000W
 (7) For the 277/480V grid: it is allowed to install up to 15,000W per string when the maximum power difference between each string is 2,000W
 (8) It is not allowed to mix S-series and P-series Power Optimizers in new installations

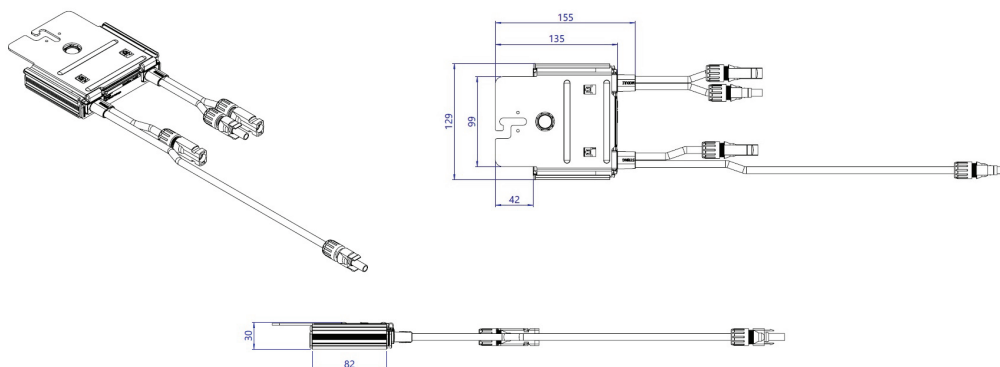

Three Phase Inverters for the 120/208V Grid for North America

SE9KUS



INVERTERS

The best choice for SolarEdge enabled systems

- Specifically designed to work with power optimizers
- Quick and easy inverter commissioning directly from a smartphone using the SolarEdge SetApp
- Internet connection through Ethernet or Wireless
- Fixed voltage inverter for longer strings
- UL1741 SA certified, for CPUC Rule 21 grid compliance
- Built-in module-level monitoring
- Integrated arc fault protection and rapid shutdown for NEC 2014, 2017 and 2020, per article 690.11 and 690.12
- Integrated Safety Switch
- Supplied with RS485 Surge Protection, to better withstand lightning events
- Small, lightweight, and easy to install outdoors or indoors on provided bracket

/ Three Phase Inverters for the 120/208V Grid⁽¹⁾ for North America SE9KUS

APPLICABLE TO INVERTERS WITH PART NUMBER		SEXKX-XXXXXBXX4
MODEL NUMBER		SE9KUS
OUTPUT		
Rated AC Power Output	9000	VA
Maximum AC Power Output	9000	VA
Output Line Connections	3 phase, 3-wire / PE (L1-L2-L3), TN, TT 3 phase, 4-wire / PE (L1-L2-L3-N), TN, TT	
AC Output Voltage Minimum-Nominal-Maximum ⁽²⁾ (L-N)	105-120-132.5	Vac
AC Output Voltage Minimum-Nominal-Maximum ⁽²⁾ (L-L)	183-208-229	Vac
AC Frequency Min-Nom-Max ⁽²⁾	59.3 - 60 - 60.5	Hz
Maximum Continuous Output Current (per Phase)	25	A
GFDI Threshold	1	A
Utility Monitoring, Islanding Protection, Country Configurable Set Points	Yes	
THD	≤ 3	%
INPUT		
Maximum DC Power (Module STC)	12150	W
Transformer-less, Ungrounded	Yes	
Maximum Input Voltage DC to Gnd	250	Vdc
Maximum Input Voltage DC+ to DC-	500	Vdc
Nominal Input Voltage DC to Gnd	200	Vdc
Nominal Input Voltage DC+ to DC-	400	Vdc
Maximum Input Current	26.5	Adc
Maximum Input Short Circuit Current	45	Adc
Reverse-Polarity Protection	Yes	
Ground-Fault Isolation Detection	1MΩ Sensitivity ⁽³⁾	
CEC Weighted Efficiency	96.5	%
Night-time Power Consumption	< 3	W
ADDITIONAL FEATURES		
Supported Communication Interfaces	RS485, Ethernet, Built-in Cellular (optional)	
Inverter Commissioning	With the SetApp mobile application using built-in access point for local connection	
Rapid Shutdown – NEC 2014, 2017 and 2020 690.12	Automatic Rapid Shutdown upon AC Grid Disconnect	
RS485 Surge Protection Plug-in	Supplied with the inverter	
Smart Energy Management	Export Limitation	
STANDARD COMPLIANCE		
Safety	UL1741, UL1741 SA, UL1699B, CSA C22.2, Canadian AFCI according to T.I.L. M-07	
Grid Connection Standards	IEEE1547, Rule 21, Rule 14 (HI)	
Emissions	FCC part15 class B	
INSTALLATION SPECIFICATIONS		
AC output conduit size / AWG range	3/4" minimum / 8-4 AWG	
DC input conduit size / AWG range	3/4" minimum / 12-6 AWG	
Number of DC inputs ⁽⁴⁾	2 pairs	
Dimensions (H x W x D)	21 x 12.5 x 10.5 / 540 x 315 x 260	in / mm
Dimensions with Safety Switch (H x W x D)	30.5 x 12.5 x 10.5 / 775 x 315 x 260	in / mm
Weight	93.6 / 42.5	lb / kg
Weight with Safety Switch	100.3 / 45.5	lb / kg
Cooling	Fans (user replaceable)	
Noise	< 55	dBA
Operating Temperature Range	-40 to +140 / -40 to +60 ⁽⁵⁾	°F / °C
Protection Rating	NEMA 3R	

(1) For 277/480V inverters refer to: <https://www.solaredge.com/sites/default/files/se-three-phase-us-inverter-277-480v-setapp-datasheet.pdf>

(2) For other regional settings please contact SolarEdge support

(3) Where permitted by local regulations

(4) Field replacement kit for 1 pair of inputs P/N: DCD-3PH-1TBK; Field replacement kit for 3 pairs of fuses and holders P/N: DCD-3PH-6FHK-S1

(5) For power de-rating information refer to: <https://www.solaredge.com/sites/default/files/se-temperature-derating-note-na.pdf>