

Details And Returns:
Sustainability Is In The Details

 MITREX™ |  Cladify™

mitrex.com - cladify.com

Designing With Sustainable Facades

In the realm of sustainable architecture, every detail counts, and one often-overlooked yet crucial aspect is panel edge closure options. These options will help to enhance the visual appeal of the building design. In this document, we will showcase Mitrex and Cladify panel edge closure solutions, offering you insights, strategies, and innovative approaches to integrate sustainable practices into your facade designs.

1. Panel Edge Closure

Mitrex takes meticulous care in the design of our panel edge closure sections, ensuring that every detail of our solar facades is crafted to perfection. These edge closures are engineered with precision, providing a seamless finish to the panels while enhancing overall durability and weather resistance. The design is not just about aesthetics; it's about safeguarding the integrity of the facade system.

- 1.1 Edge Filled Closure (EF)
Color: Matte Black, White Brass, Chrome

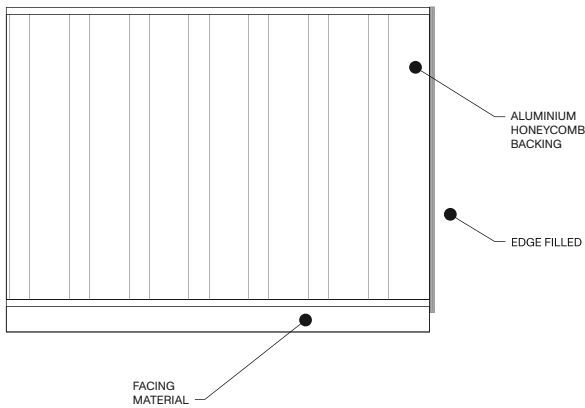

- 1.2 L-Frame Edge Closure - Up To the Facing

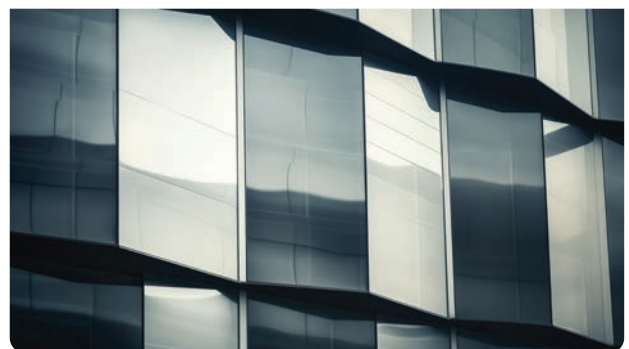
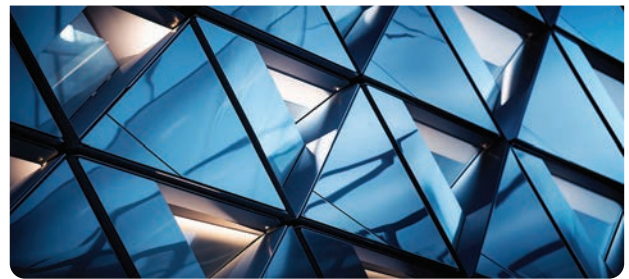
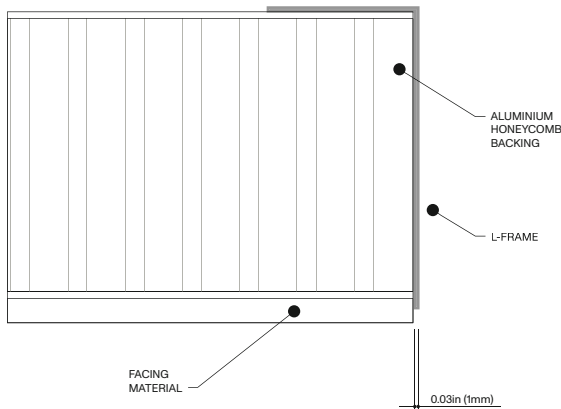

• 1.3 L-Frame Edge Closure - Facing Aligned

• L-Frame Facing Align - 2mm

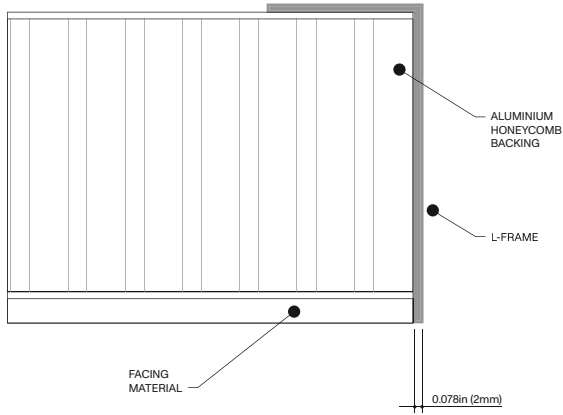

• L-Frame Facing Align - 4mm

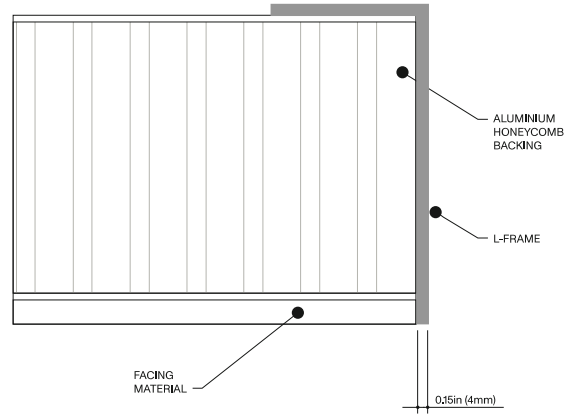

• L-Frame Facing Align - 6mm

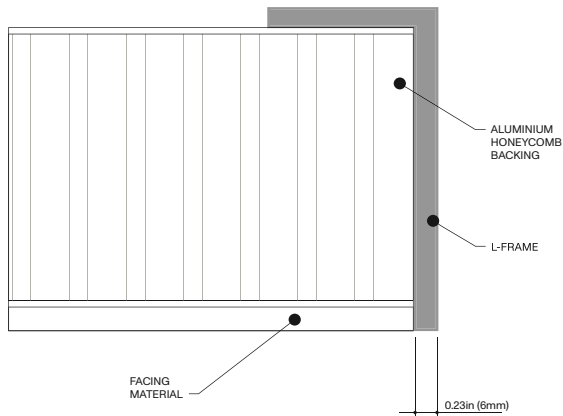

• 1.4 L-Frame Edge Closure - Protruded

• L-Frame Facing Align - 4mm

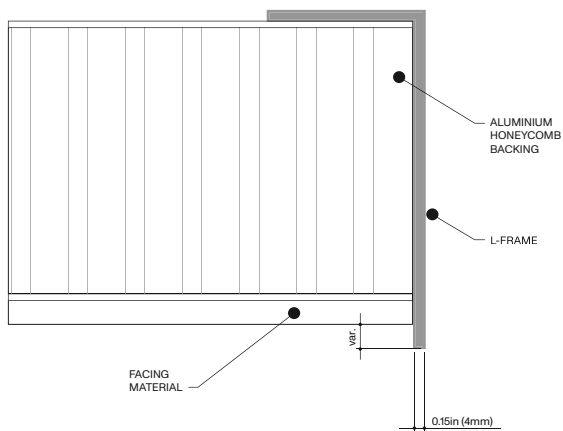

• L-Frame Facing Align - 6mm

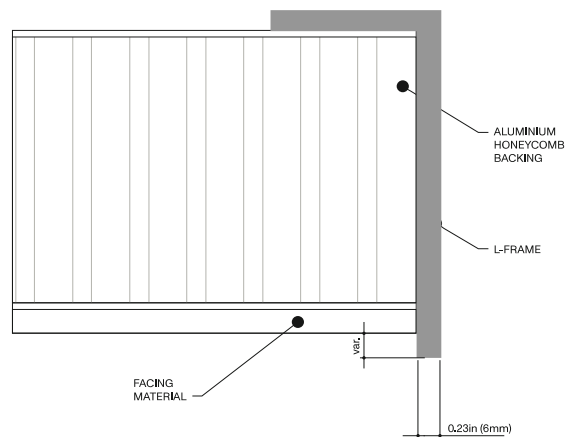

2. Panel To Panel With Profile Frame

At Mitrex, we understand that the magic of a stunning facade lies in the details. Our panel-to-panel details and profile frames are designed with this in mind, ensuring a harmonious and precise alignment between each solar panel. These connecting details are meticulously engineered, not only to achieve a visually seamless facade but also to ensure structural integrity and ease of installation.

Color: Matte, Black, White, Brass, Chrome

- 2.1 Face Alignment (E1)

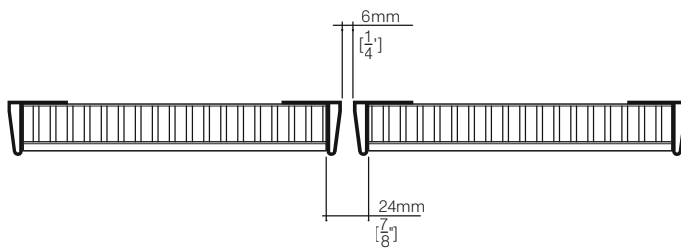

Horizontal

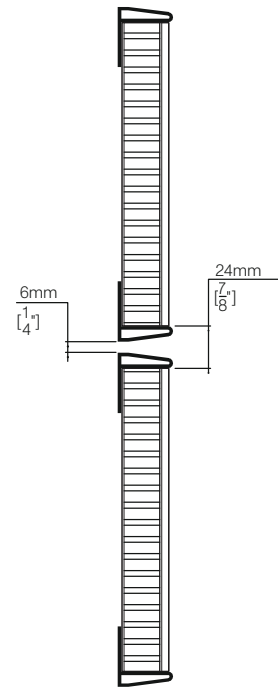

Vertical

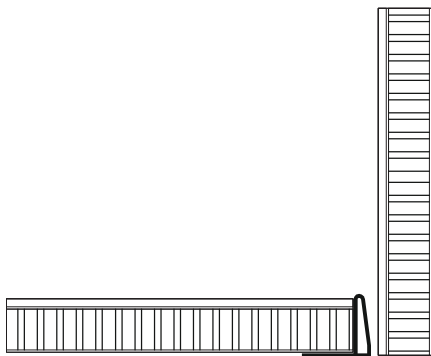

Inner Corner

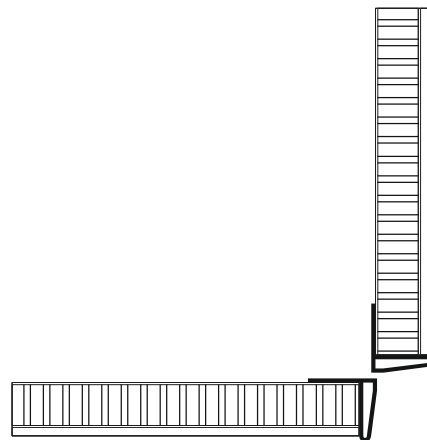

Outer Corner

• 2.2 Face Protruded (E1-P)

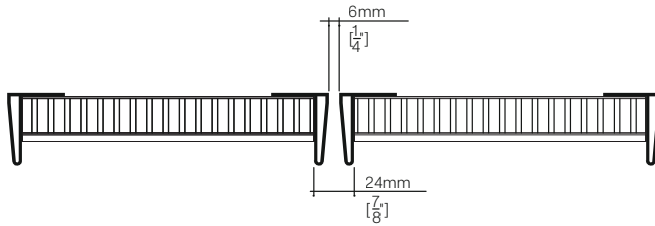
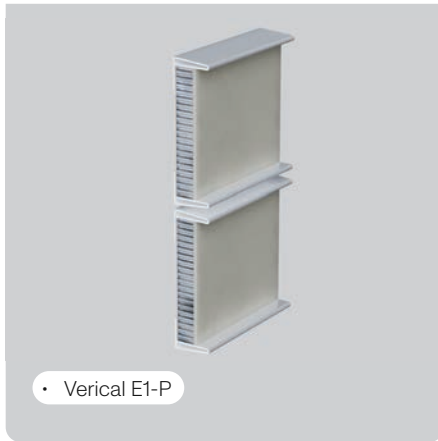

Horizontal

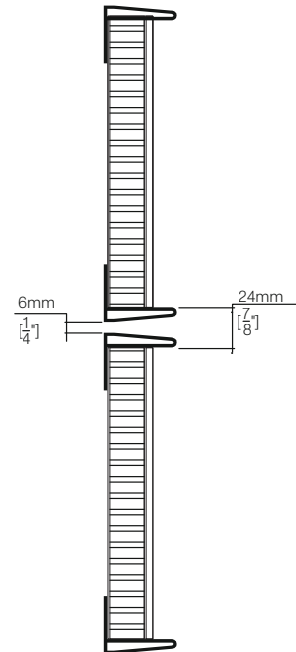

Vertical

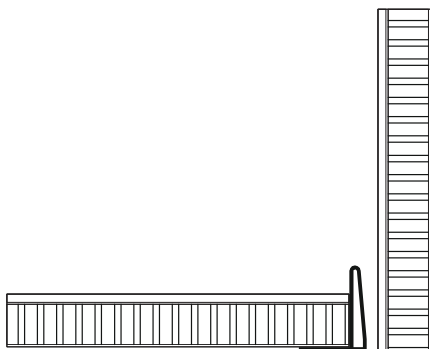

Inner Corner

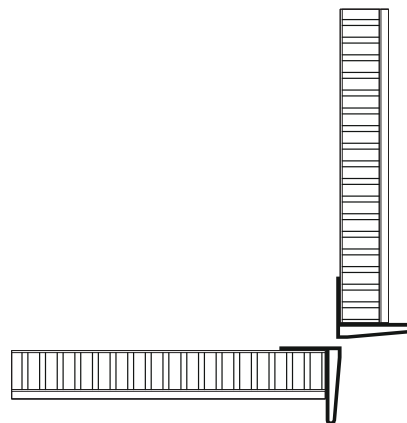

Outer Corner

• 2.3 Face Alignment (E2)

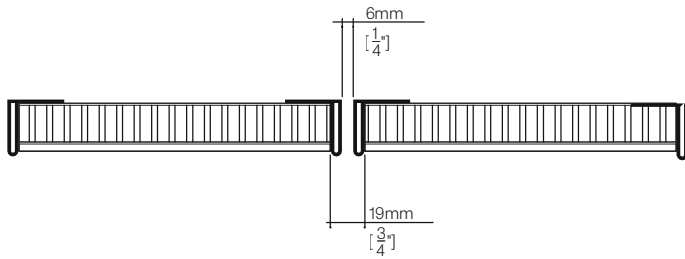

Horizontal

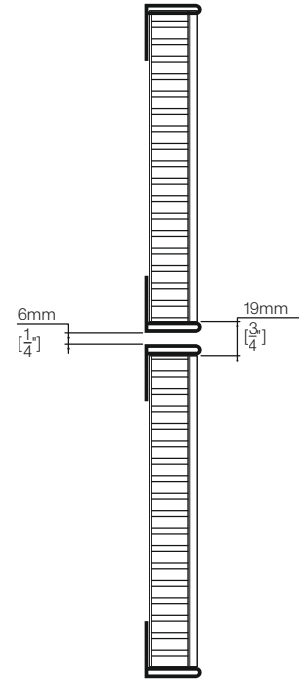

Vertical

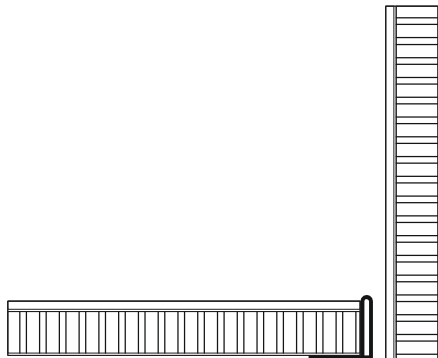

Inner Corner

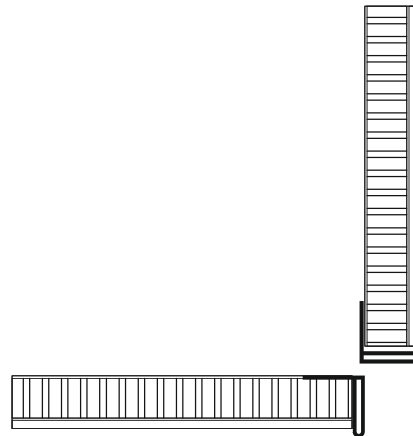

Outer Corner

- 2.4 Face Protruded (E2-P)

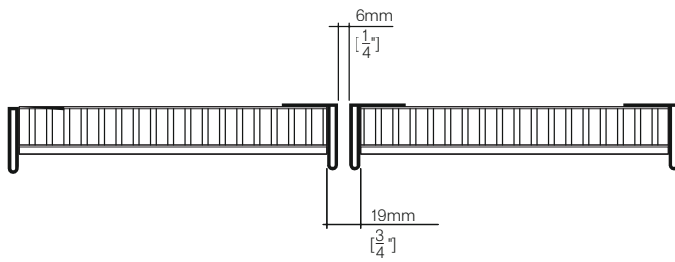
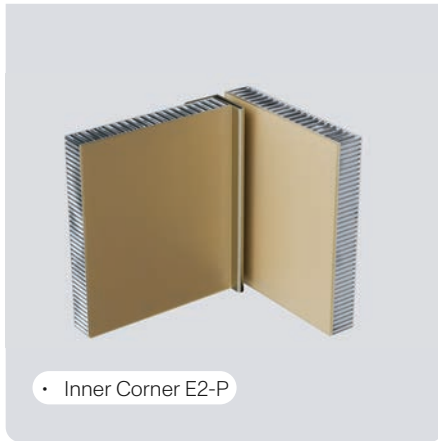

Horizontal

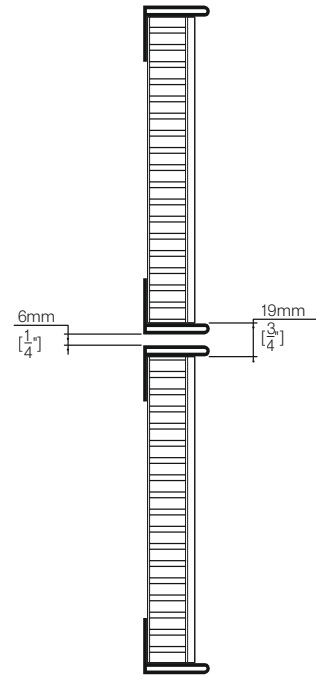

Vertical

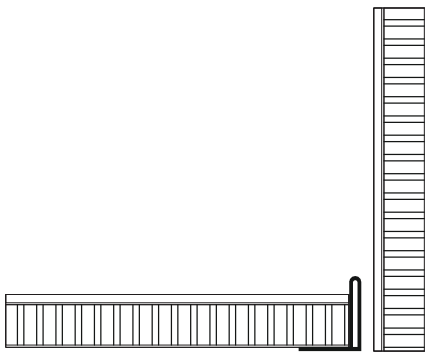

Inner Corner

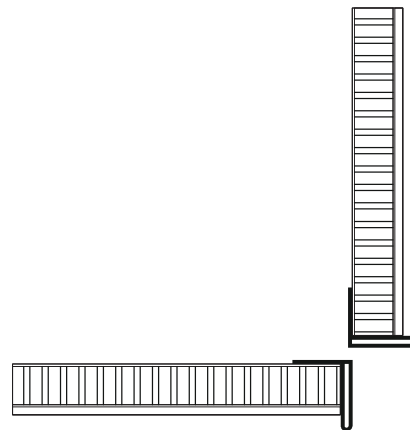

Outer Corner

- 2.5 Face Alignment (E3)

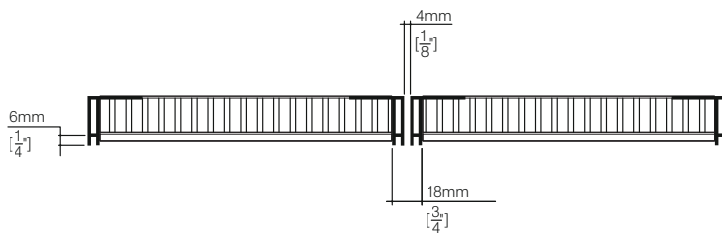
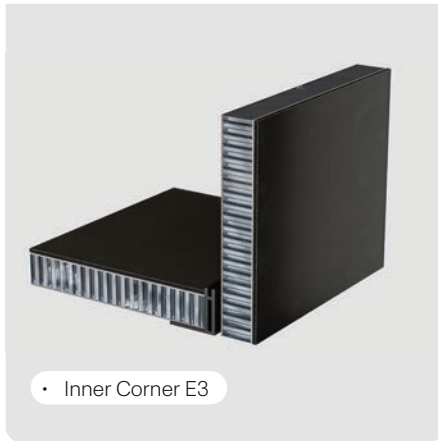

Horizontal

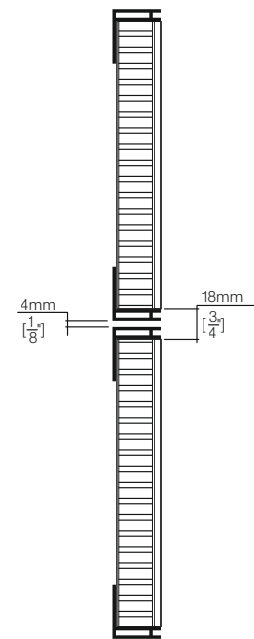

Vertical

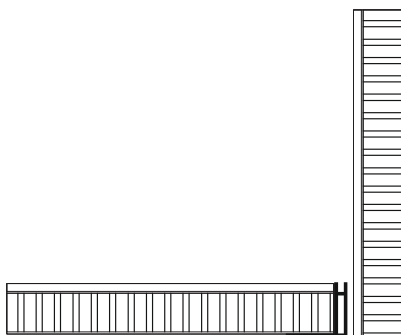

Inner Corner

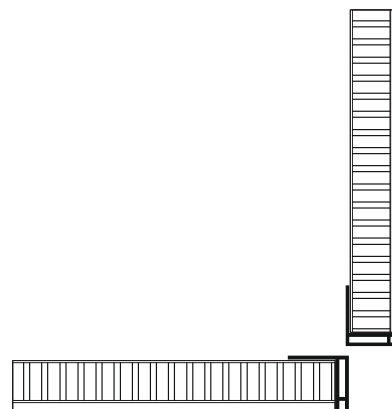

Outer Corner

- 2.6 Face Protruded (E3-P)

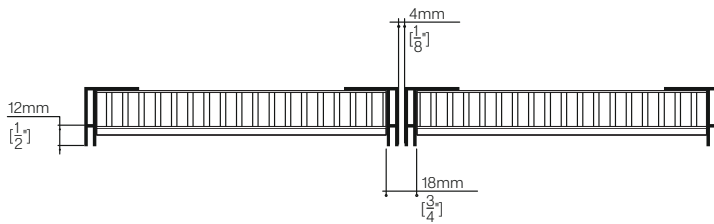
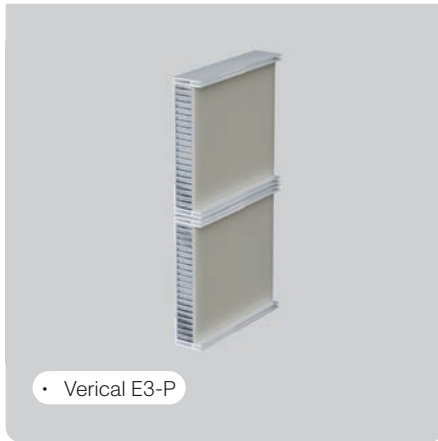

Horizontal

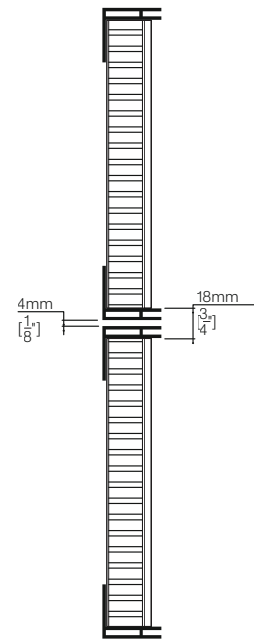

Vertical

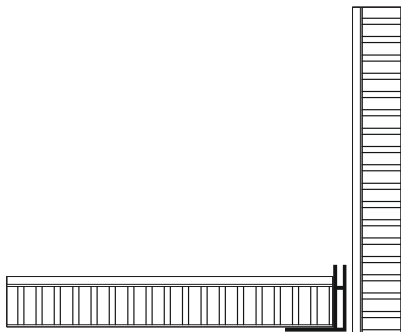

Inner Corner

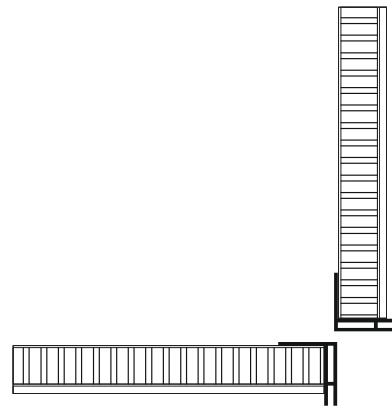

Outer Corner

- 2.7 Face Alignment (E4)

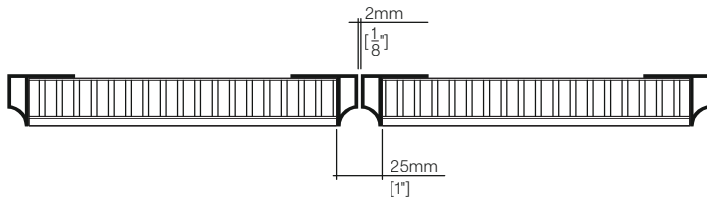

Horizontal

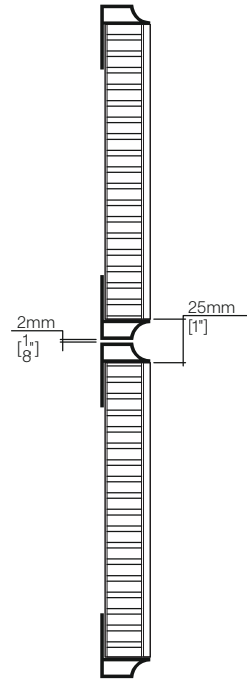

Vertical

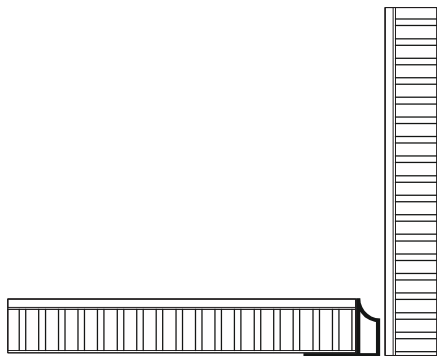

Inner Corner

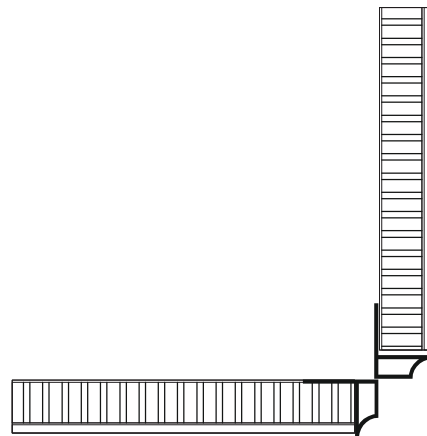

Outer Corner

- 2.8 Face Protruded (E4-P)

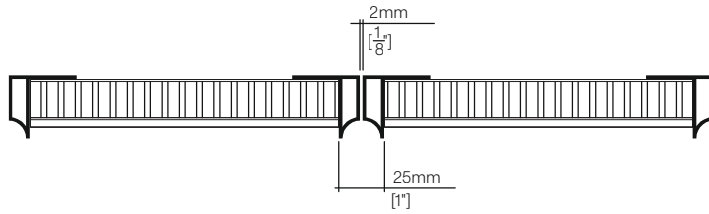

Horizontal

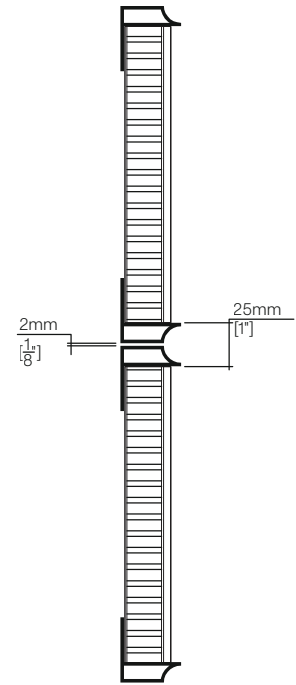

Vertical

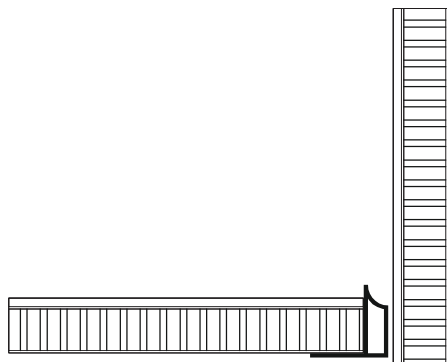

Inner Corner

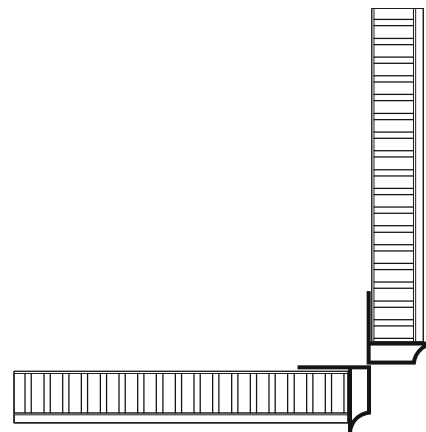

Outer Corner

- 2.9 Face Alignment (E5)

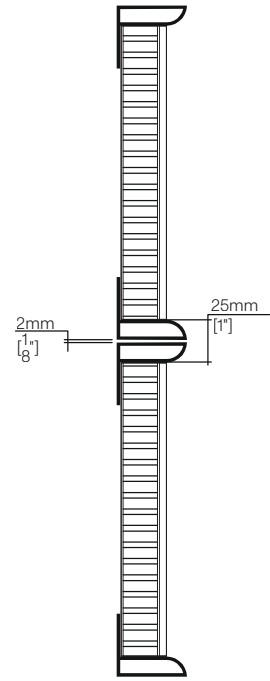

Vertical

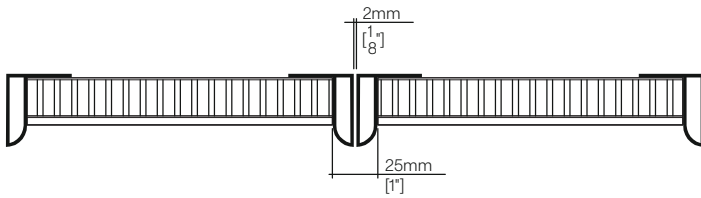

Horizontal

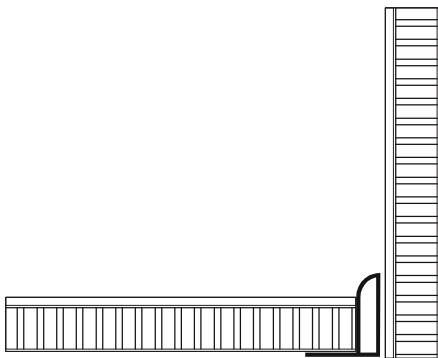

Inner Corner

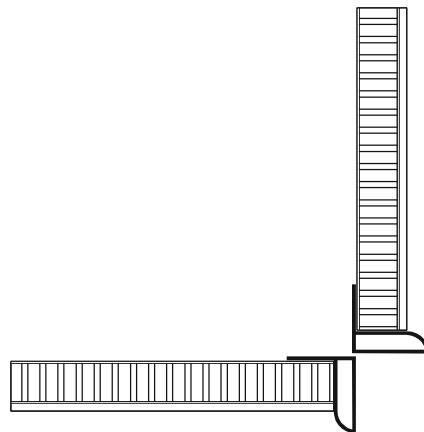

Outer Corner

- 2.10 Face Protruded (E5-P)

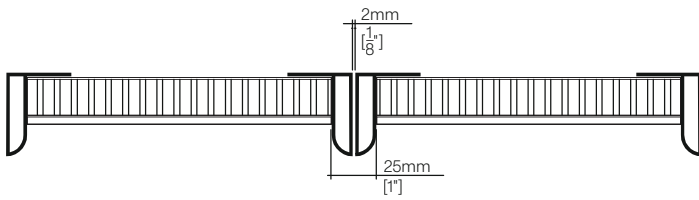
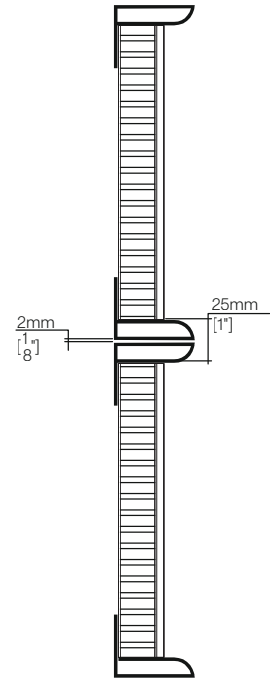

Horizontal

Vertical

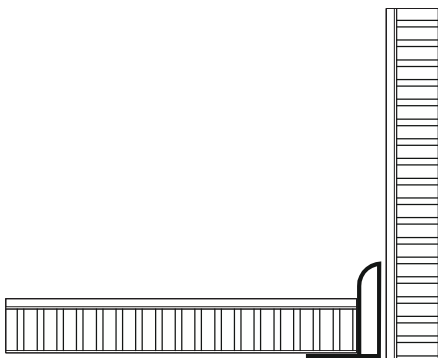

Inner Corner

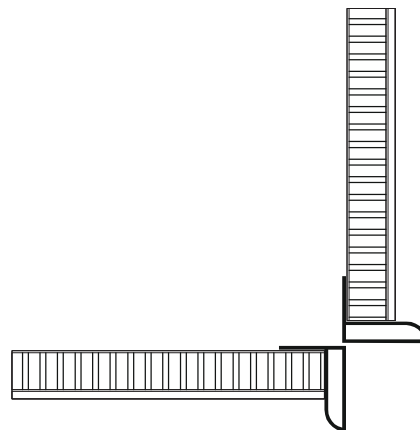

Outer Corner

• 2.11 Face Alignment (E6)

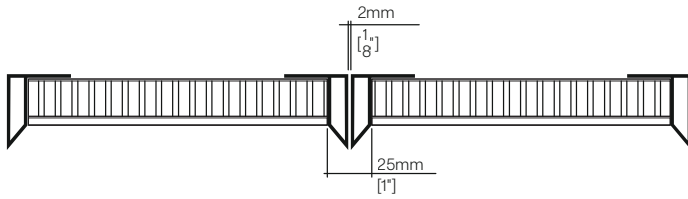
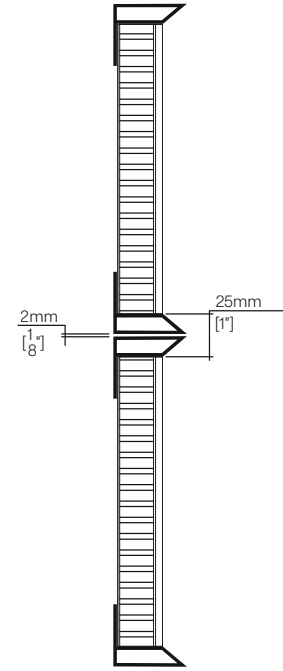

Horizontal

Vertical

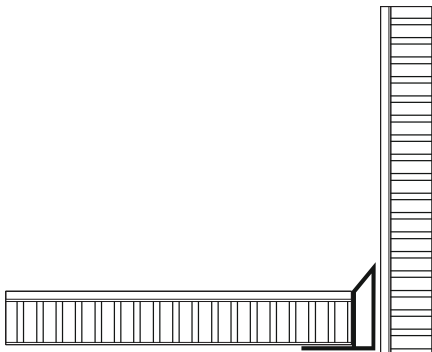

Inner Corner

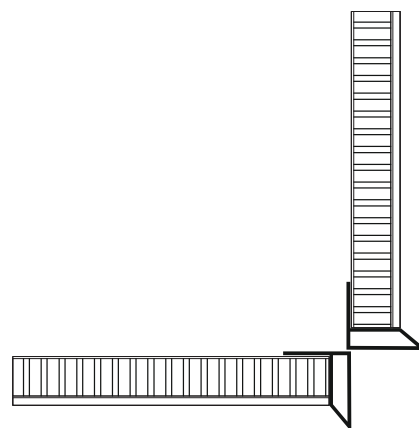

Outer Corner

- 2.12 Face Protruded (E6-P)

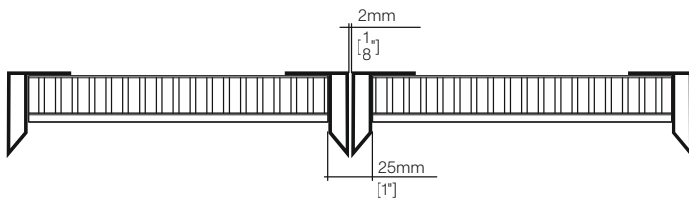

Horizontal

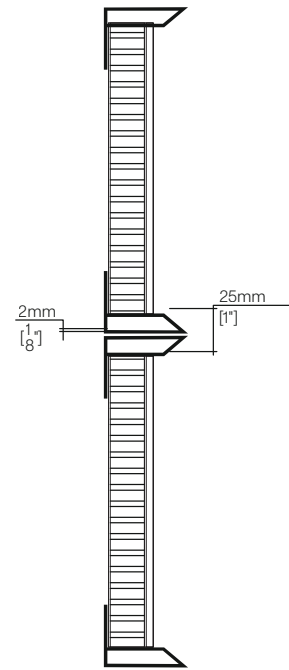

Vertical

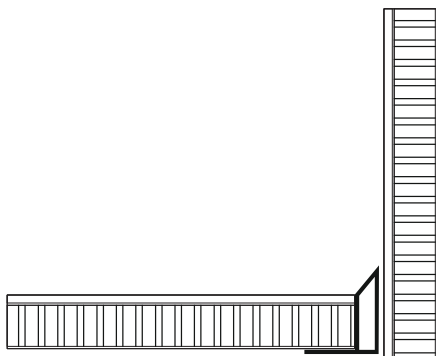

Inner Corner

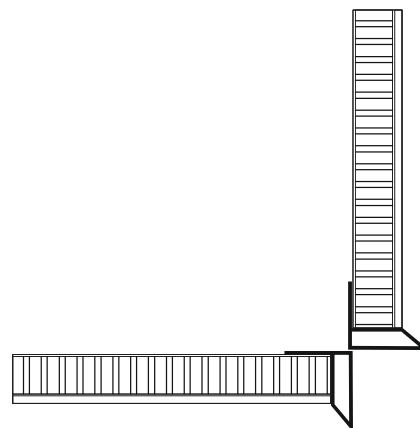

Outer Corner

- 2.13 Face Alignment (E7)

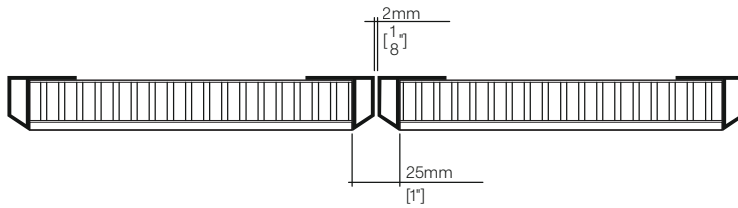
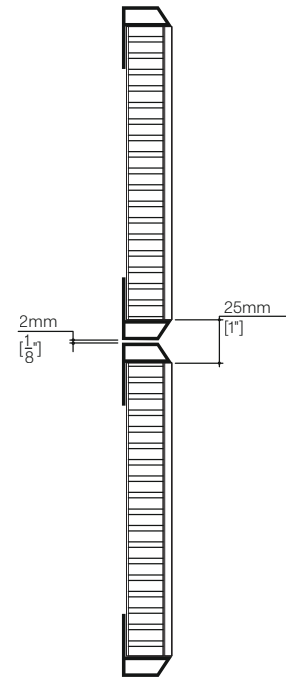
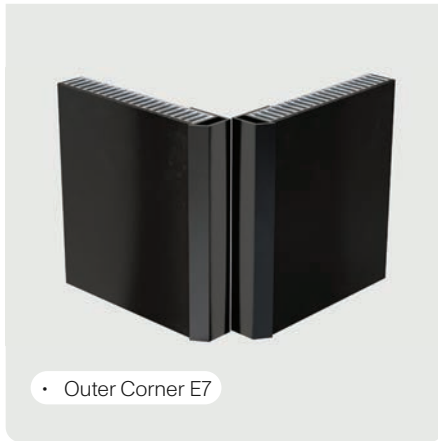

Horizontal

Vertical

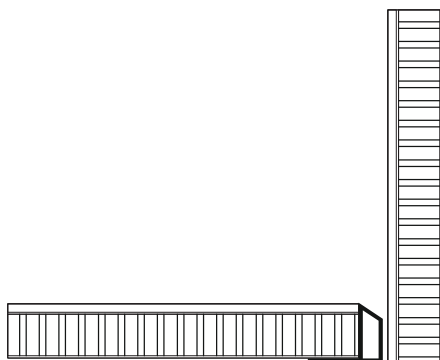

Inner Corner

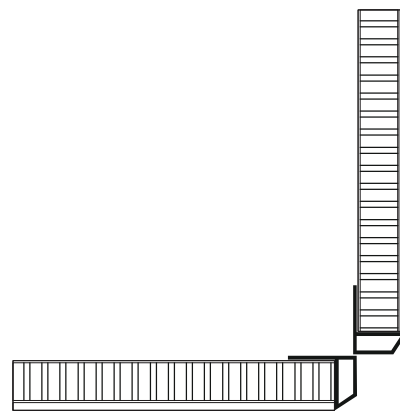

Outer Corner

- 2.14 Face Protruded (E7-P)

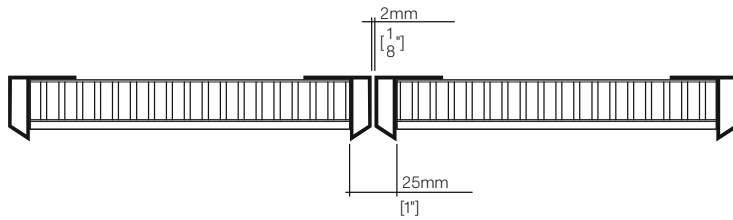
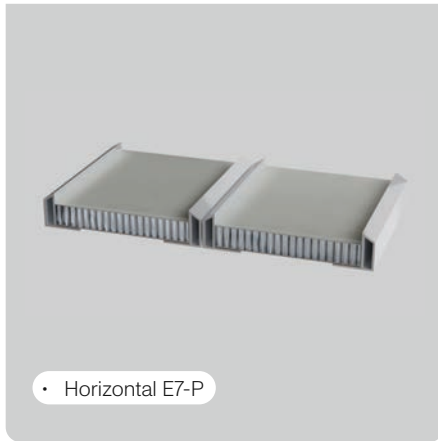

Horizontal

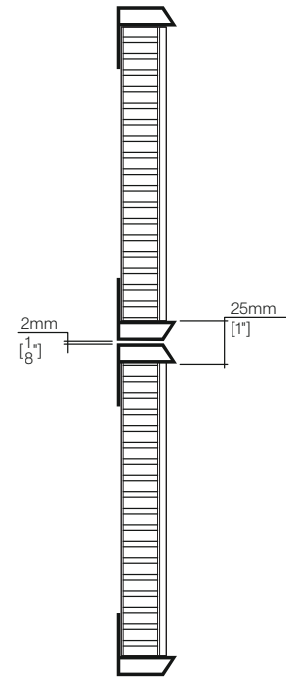

Vertical

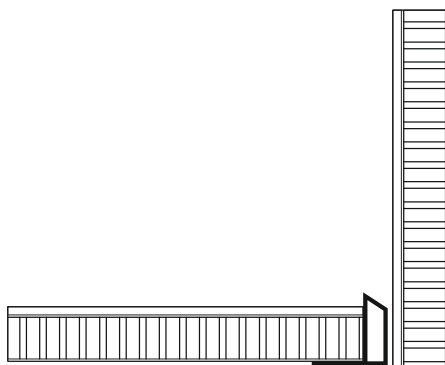

Inner Corner

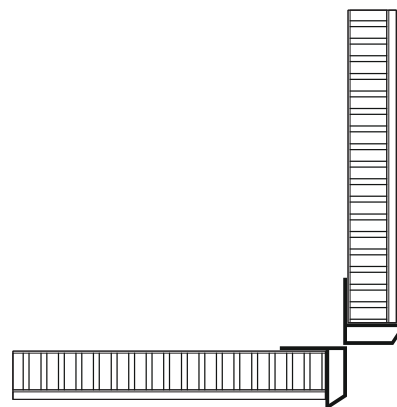

Outer Corner

3. Termination To Other Materials

With Mitrex solar facades, the transition from our panels to other materials is executed with exceptional care and precision. These termination details are crafted to ensure a flawless integration, where the end of each panel meets alternative materials, like windows, doors, and any other component in a harmonious blend.

Color: Matte, Black, White, Brass, Chrome

- 3.1 Metal Flashing - MF1

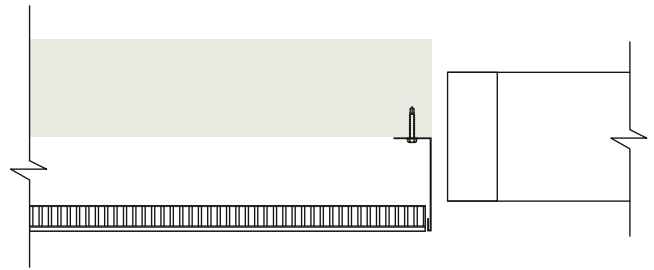

- 3.2 Metal Flashing - MF2

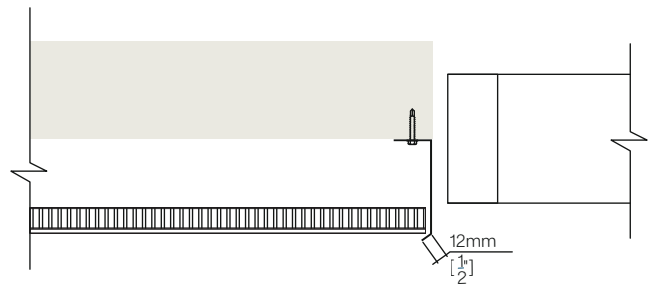

• 3.3 Metal Flashing - MF3

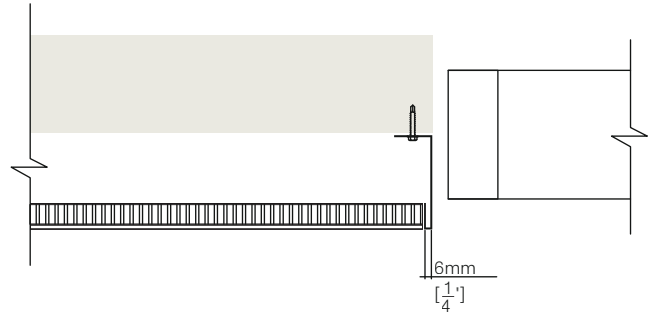

• 3.4 Metal Flashing - MF4

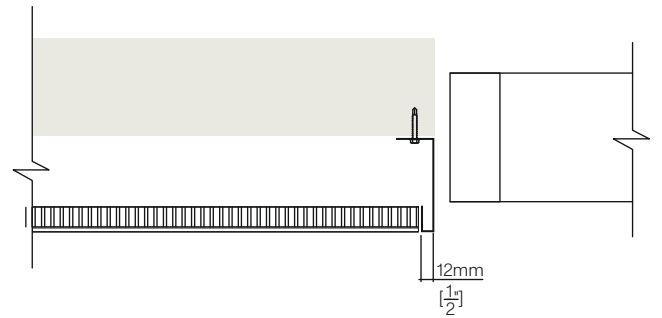

• 3.5 Panel Return PR-1

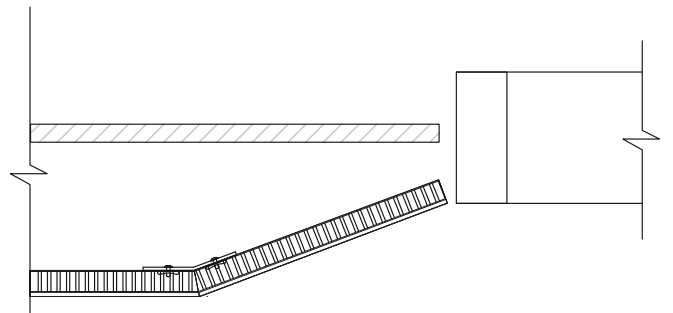

- 3.6 Panel Return PR-2

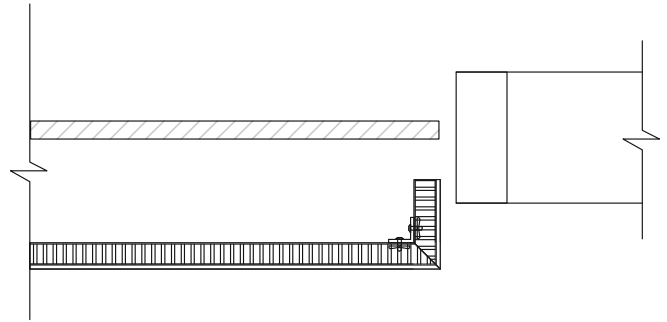

- 3.7 Panel Return PR-3

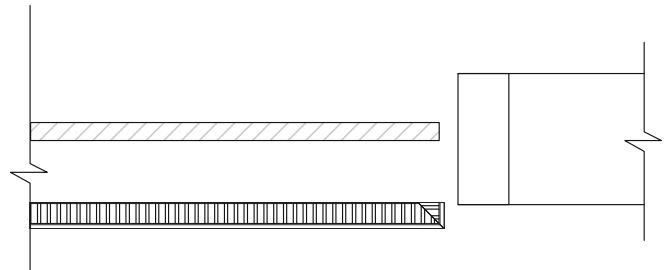

- 3.8 Panel Return PR-3

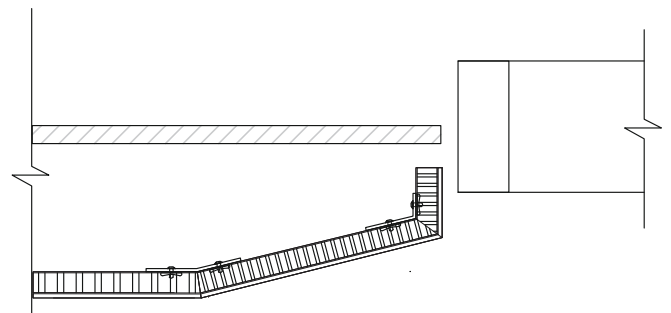

4. Panel Metal Accents

Mitrex solar facades are not just about harnessing energy; they are about creating a visual impact. Our use of metal accents on the panels is a testament to this philosophy. The metal accents offer aesthetic appeal without compromising the functionality of the solar panel, and are available in a variety of colors and configurations.

Color: Matte, Black, Whit, Brass, Chrome

- 4.1 Face Alignment (A1)

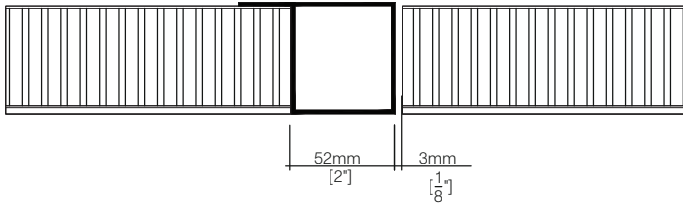
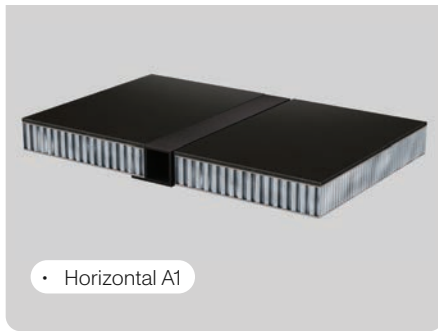

Horizontal

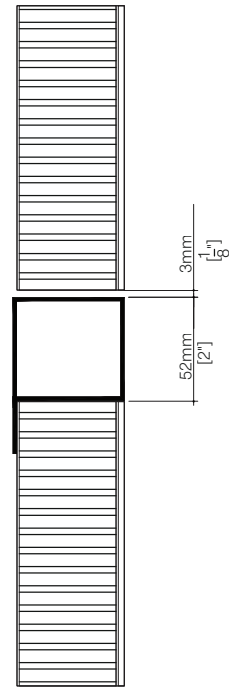

Vertical

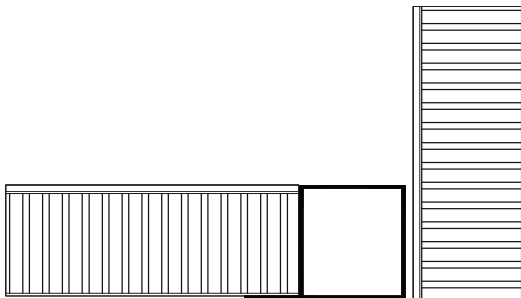

Inner Corner

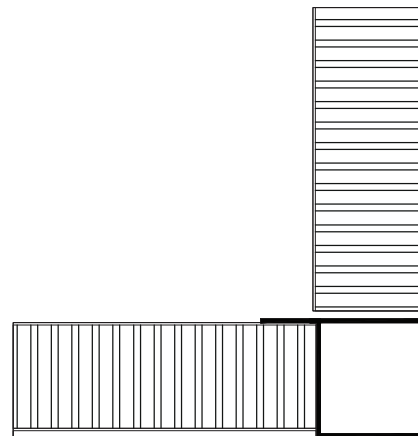

Outer Corner

- 4.2 Face Protruded (A1-P)

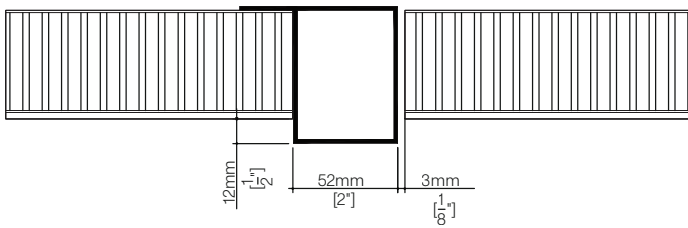

Horizontal

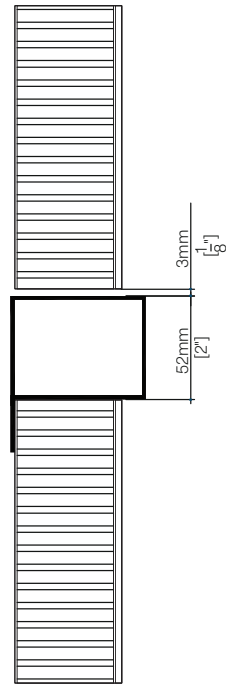

Vertical

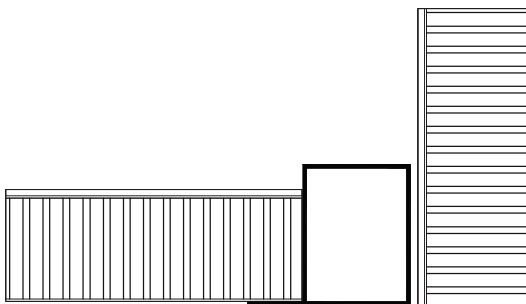

Inner Corner

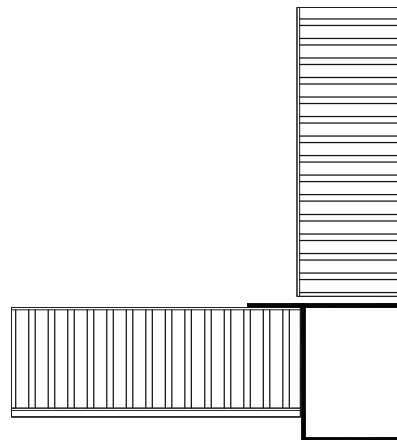

Outer Corner

• 4.3 Face Alignment (A2)

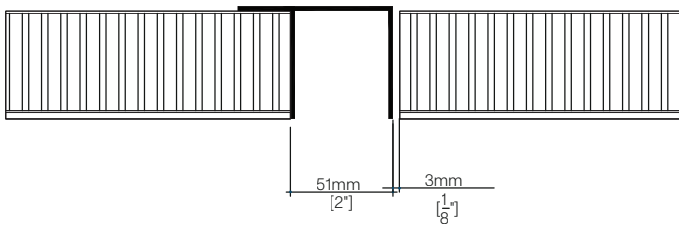

Horizontal

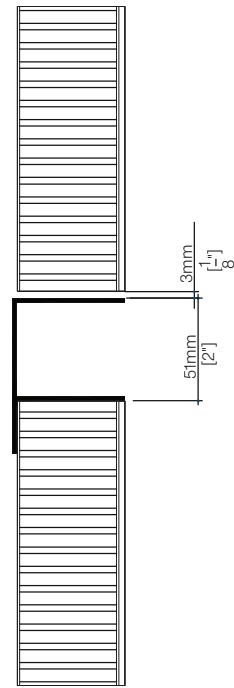

Vertical

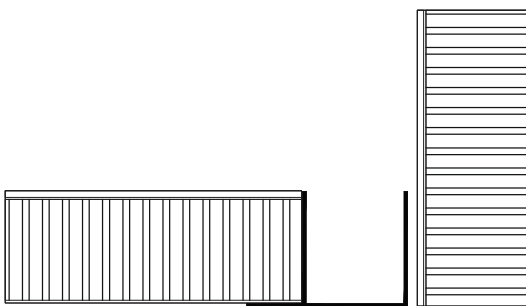

Inner Corner

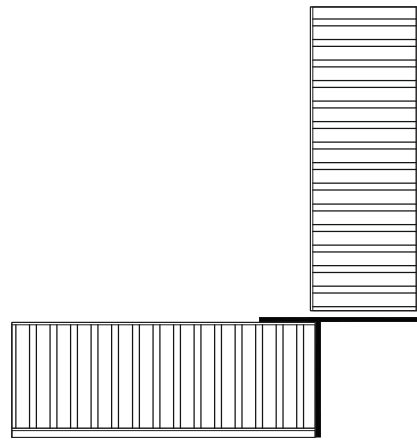

Outer Corner

• 4.4 Face Alignment (A2-P)

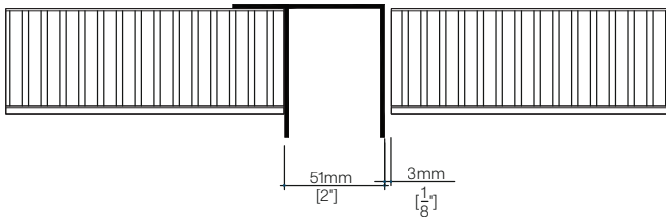
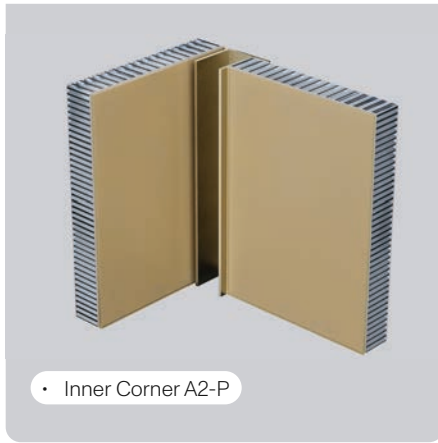

Horizontal

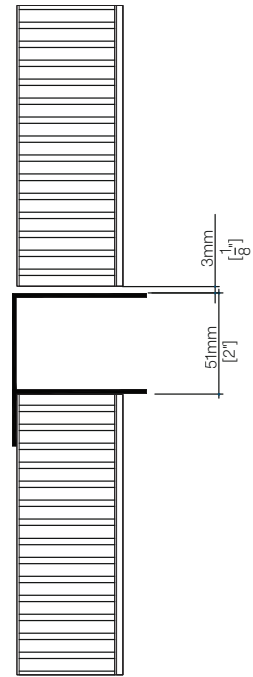

Vertical

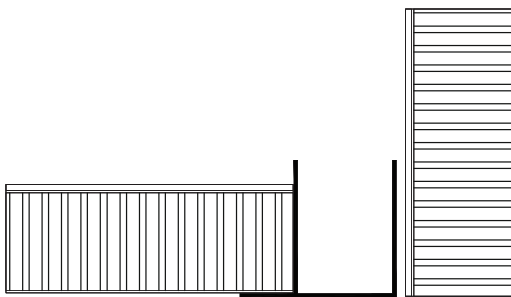

Inner Corner

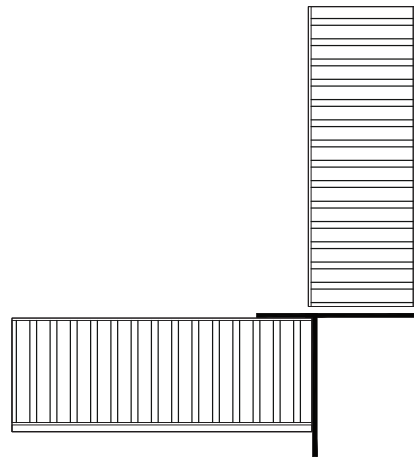

Outer Corner

- 4.5 Face Alignment (A3)

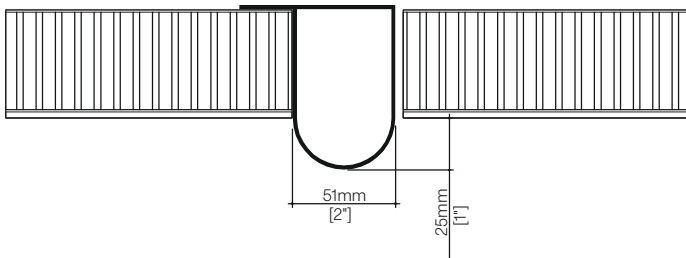
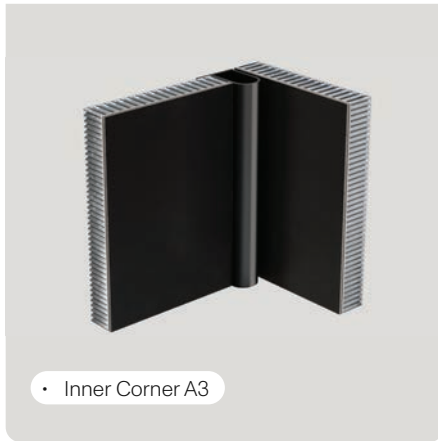

Horizontal

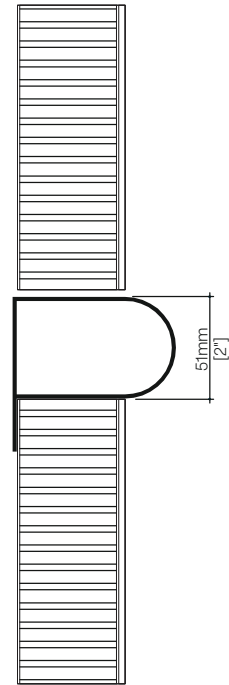

Vertical

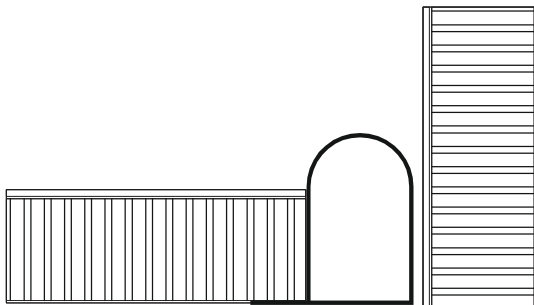

Inner Corner

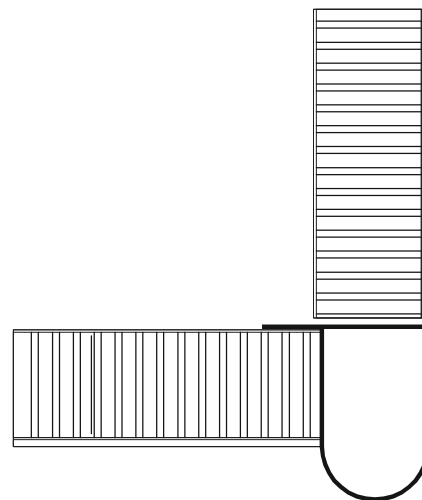

Outer Corner

- 4.6 Face Protruded (A3-P)

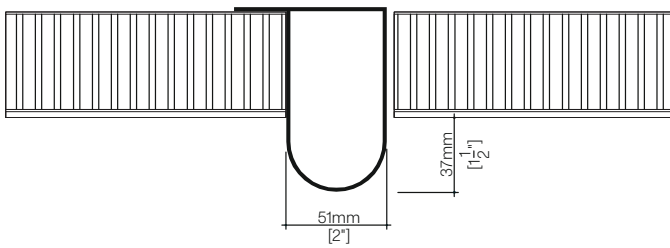
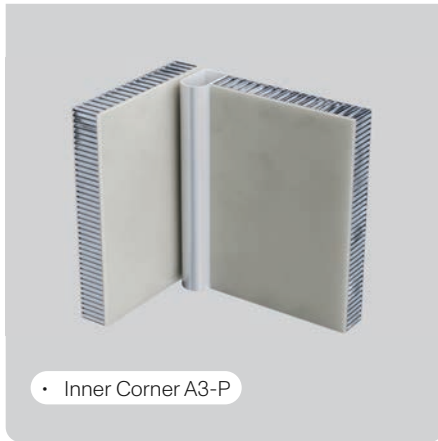

Horizontal

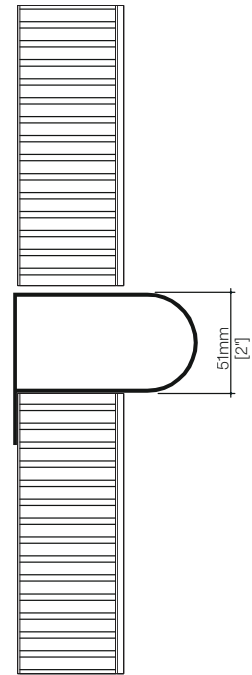

Vertical

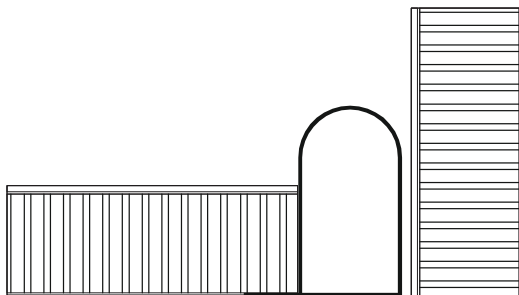

Inner Corner

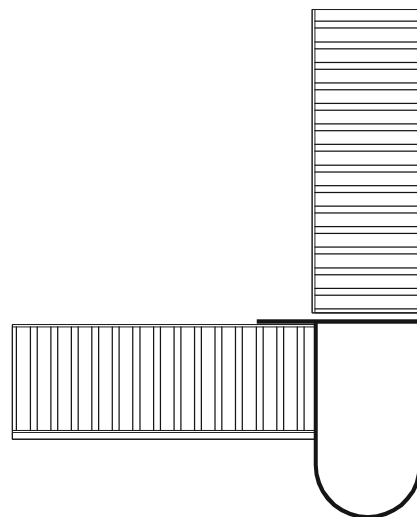

Outer Corner

- 4.7 Face Alignment (A4)

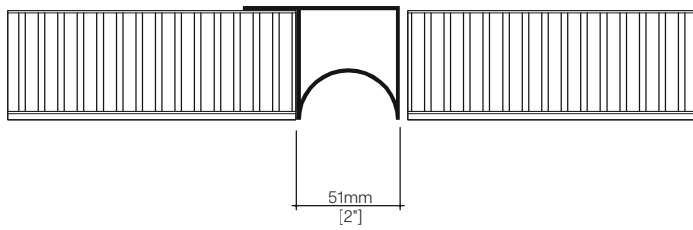
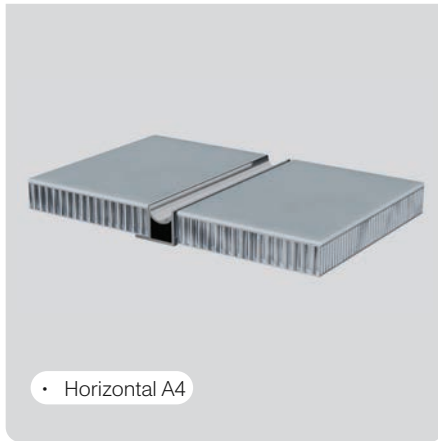

Horizontal

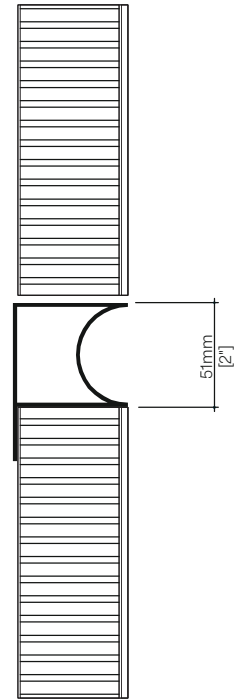

Vertical

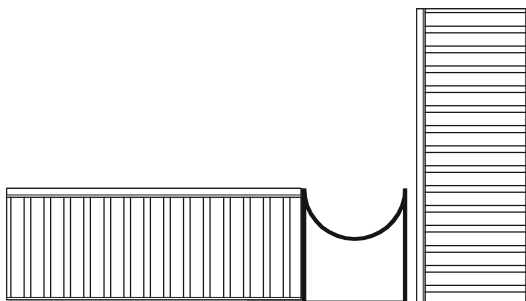

Inner Corner

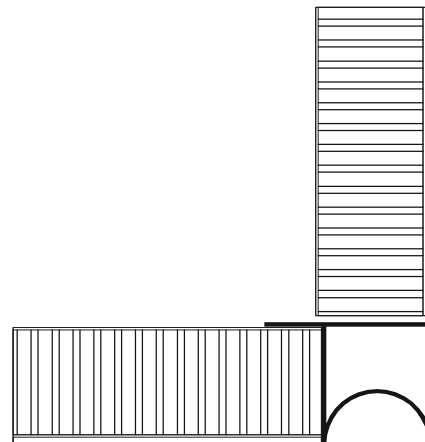

Outer Corner

- 4.8 Face Protruded (A4-P)

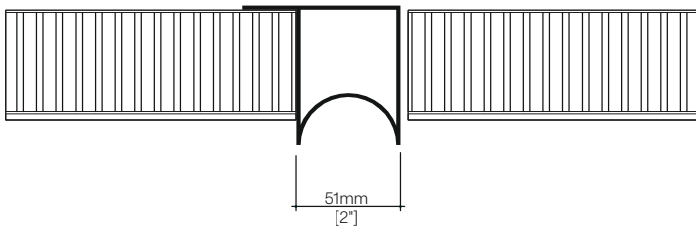
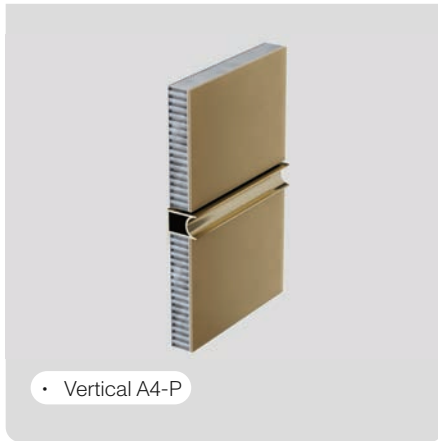

Horizontal

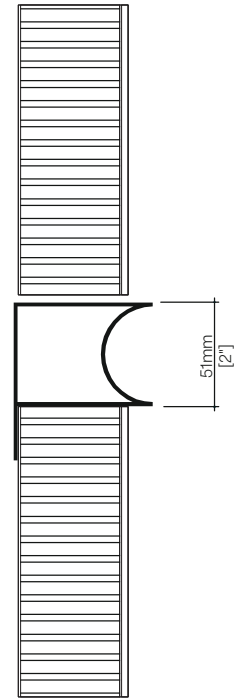

Vertical

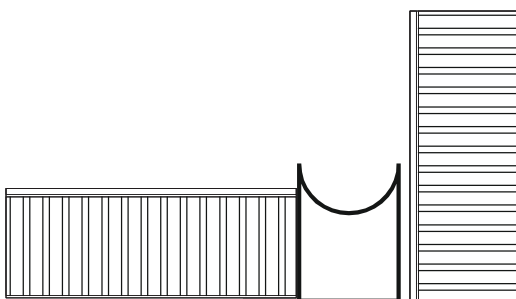

Inner Corner

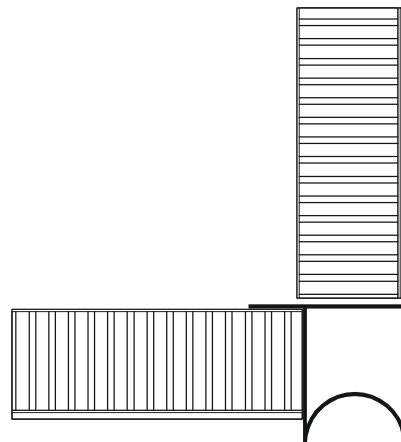

Outer Corner

• 4.9 Face Alignment (A5)

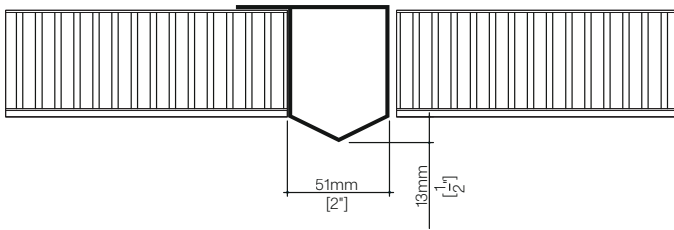
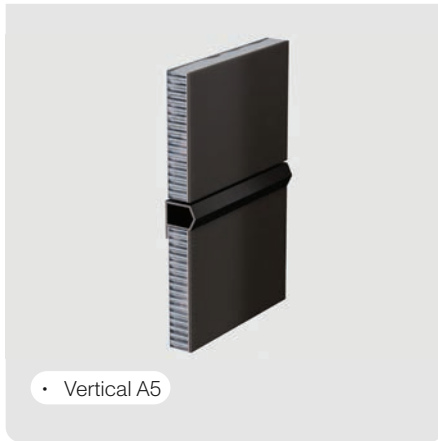

Horizontal

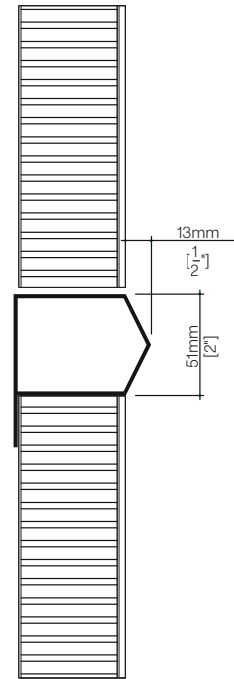

Vertical

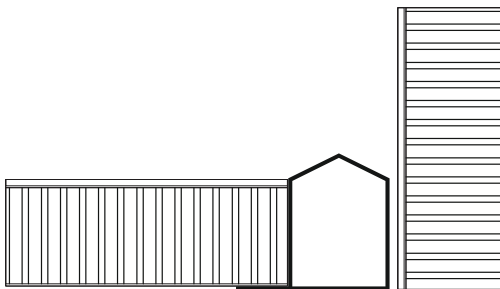

Inner Corner

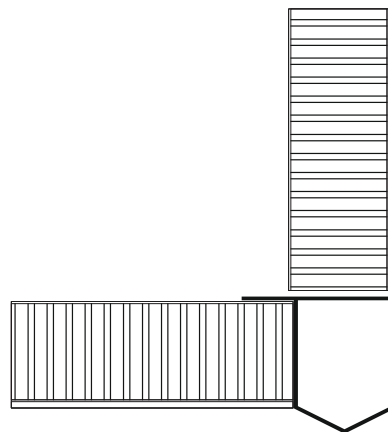

Outer Corner

- 4.10 Face Protruded (A5-P)

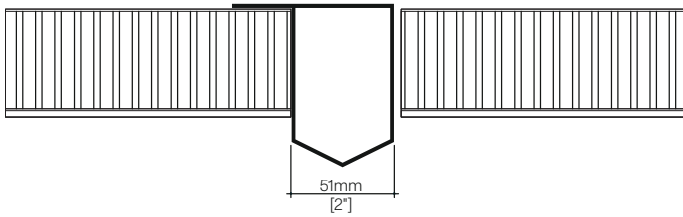

Horizontal

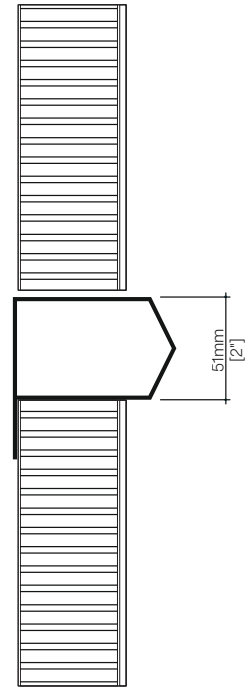

Vertical

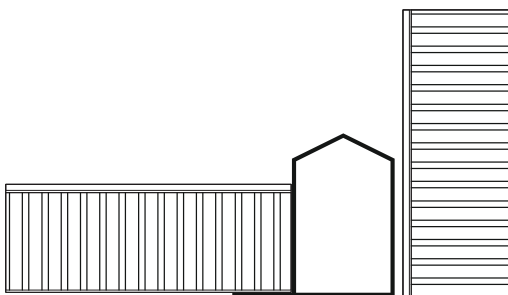

Inner Corner

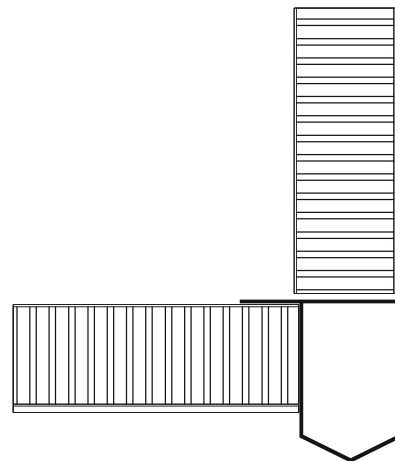

Outer Corner

- 4.11 Face Alignment (A6)

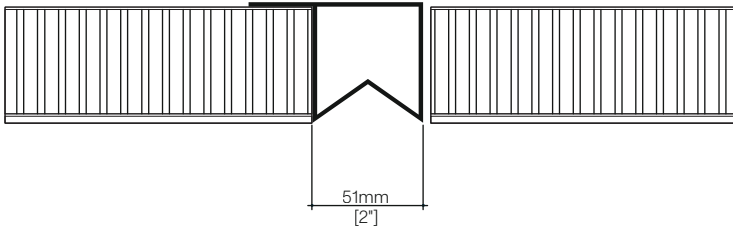
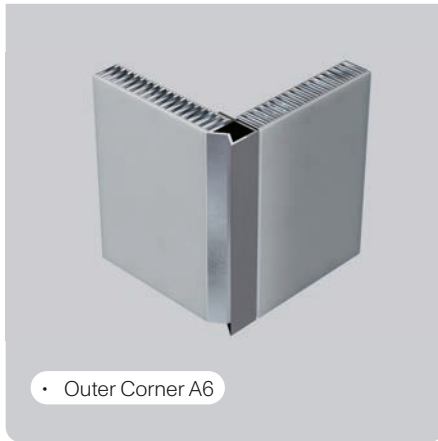

Horizontal

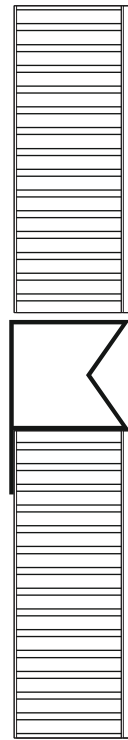

Vertical

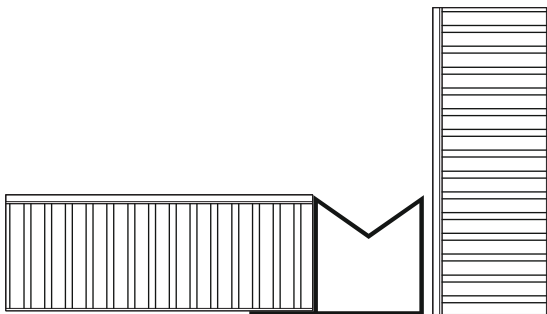

Inner Corner

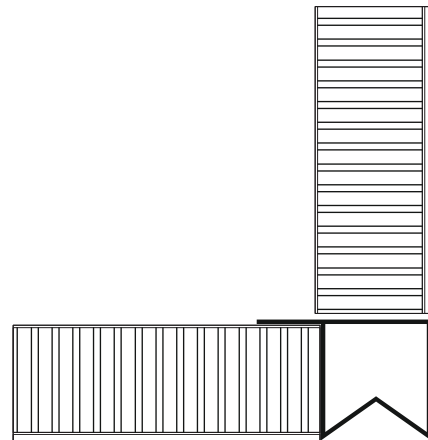

Outer Corner

- 4.12 Face Protruded (A6-P)

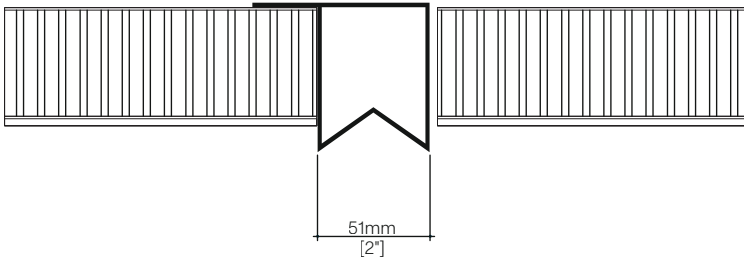
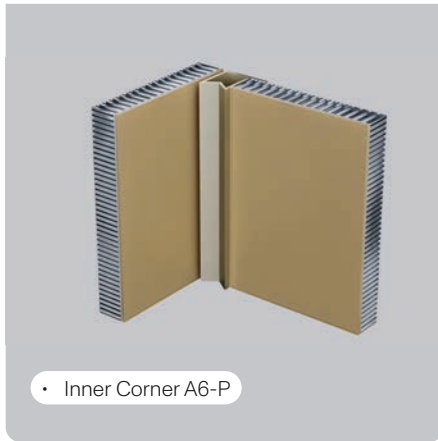

Horizontal

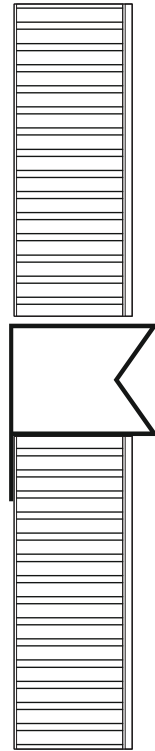

Vertical

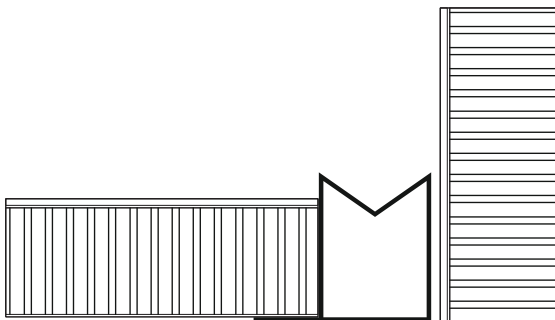

Inner Corner

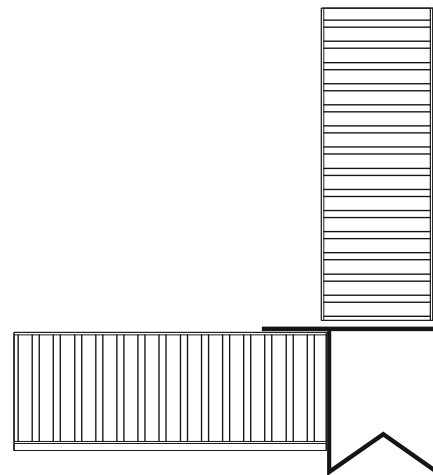

Outer Corner

• 4.13 Face Alignment (A7)

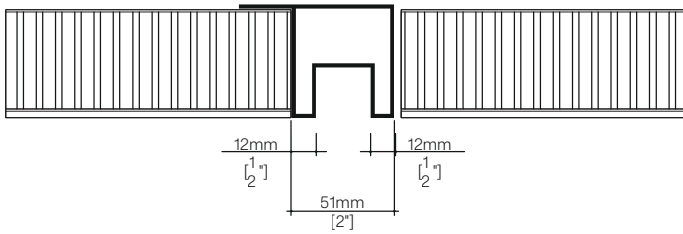

Horizontal

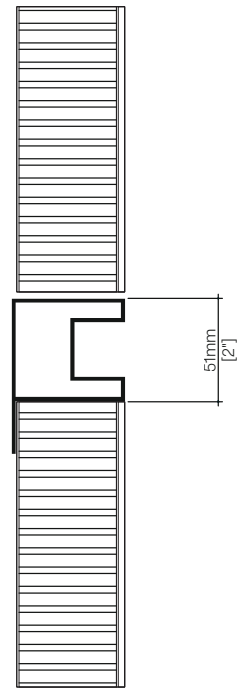

Vertical

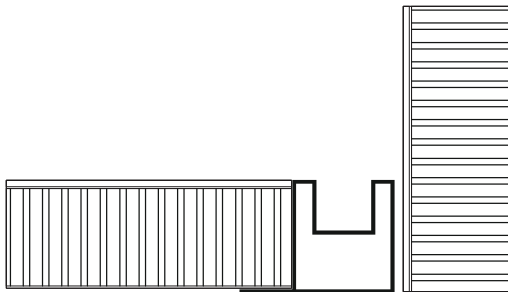

Inner Corner

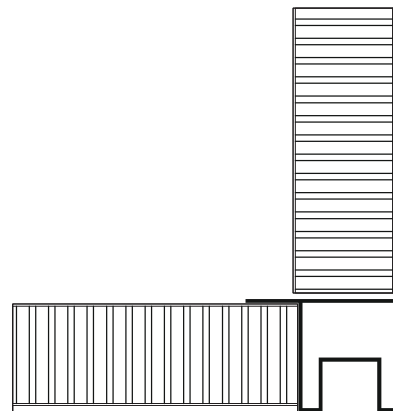

Outer Corner

- 4.14 Face Protruded (A7-P)

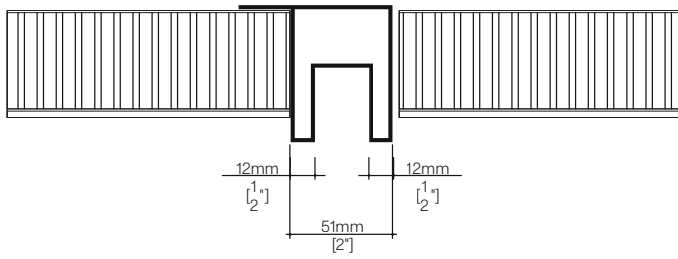
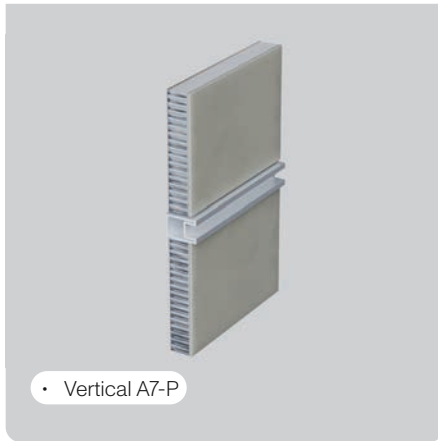

Horizontal

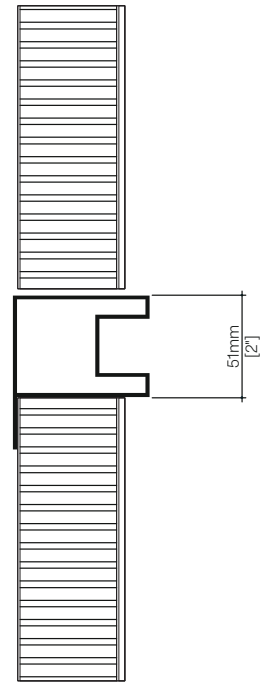

Vertical

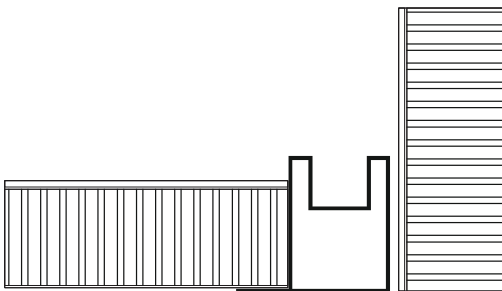

Inner Corner

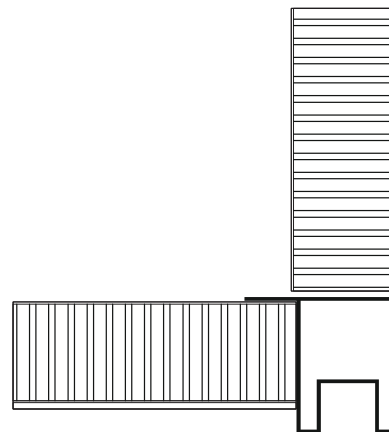

Outer Corner

- 4.15 Face Alignment (A8)

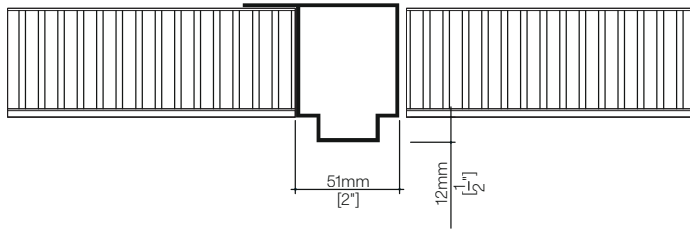

Horizontal

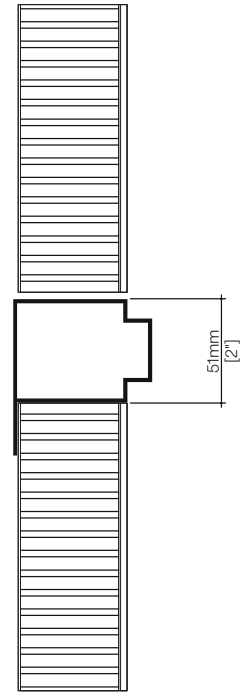

Vertical

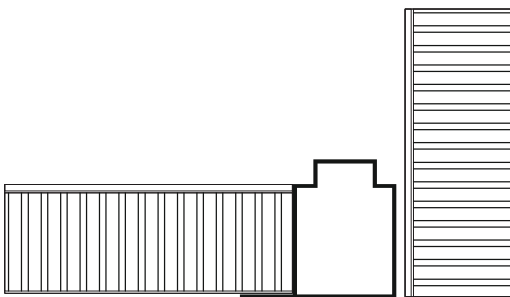

Inner Corner

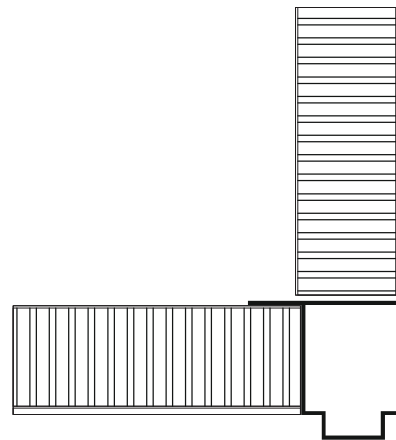

Outer Corner

- 4.16 Face Protruded (A8-P)

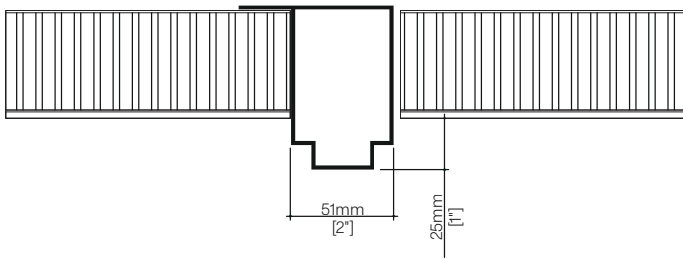
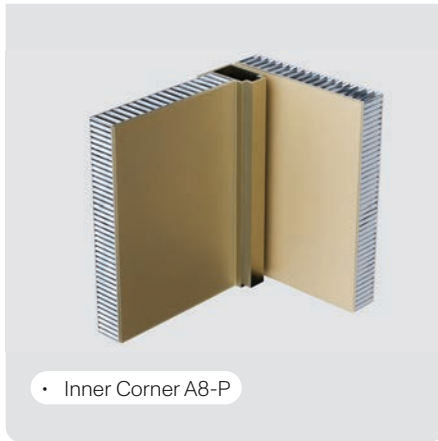

Horizontal

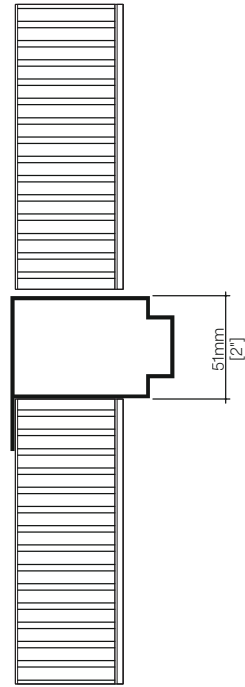

Vertical

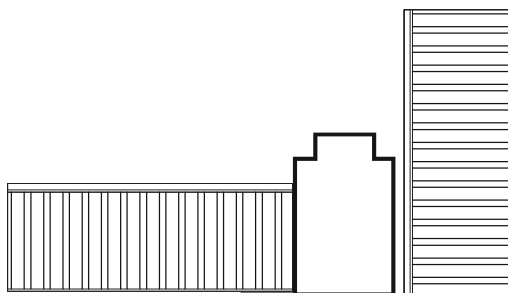

Inner Corner

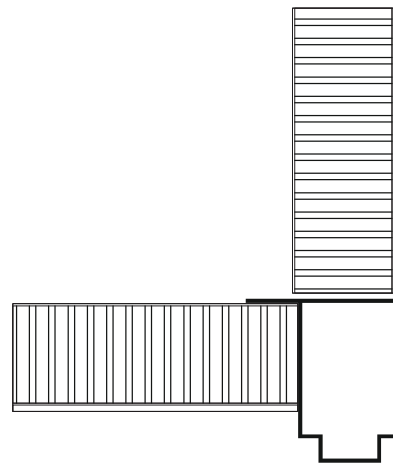

Outer Corner

• 4.17 Face Alignment (A9)

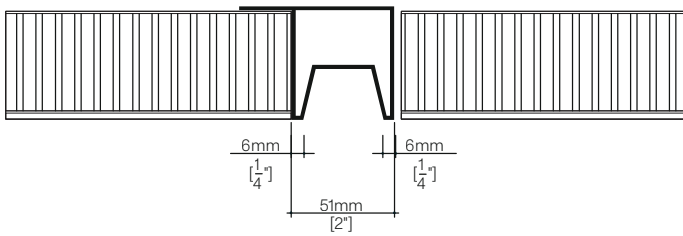
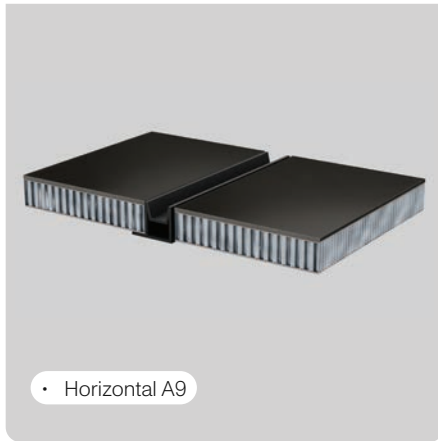

Horizontal

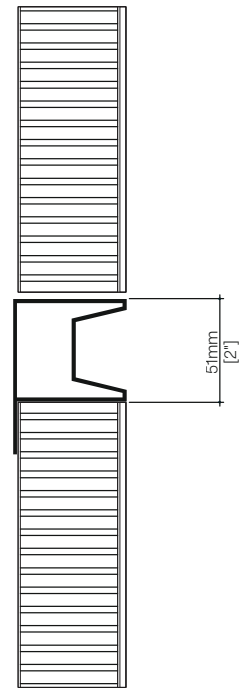

Vertical

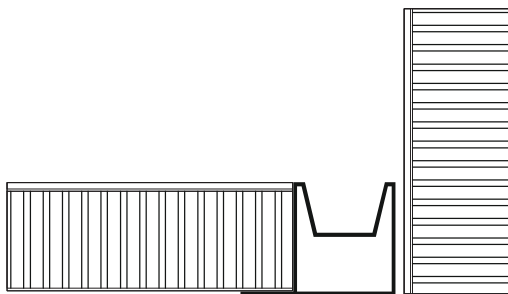

Inner Corner

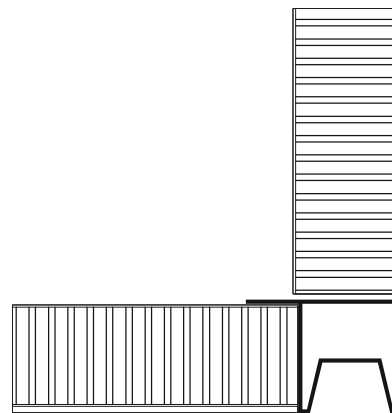

Outer Corner

- 4.18 Face Protruded (A9-P)

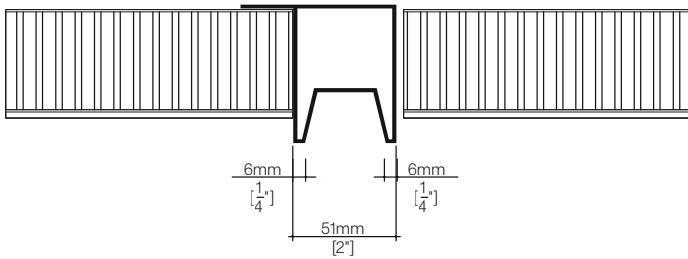

Horizontal

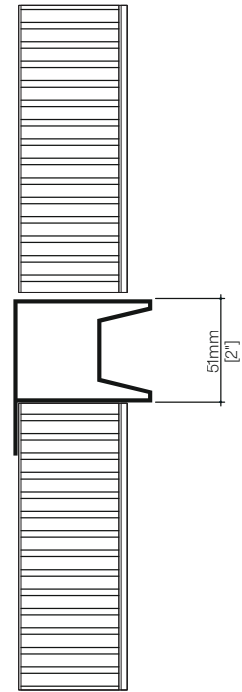

Vertical

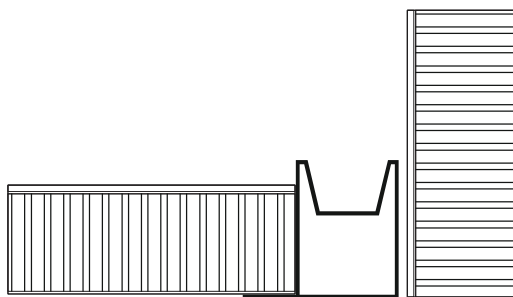

Inner Corner

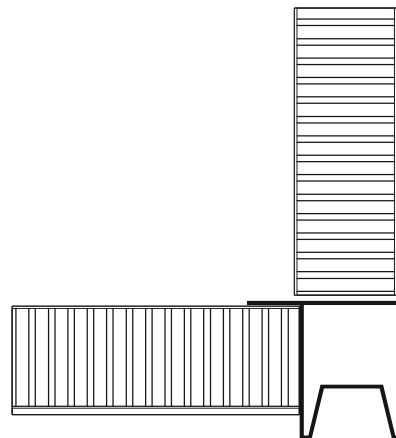

Outer Corner

• 4.19 Face Alignment (A10)

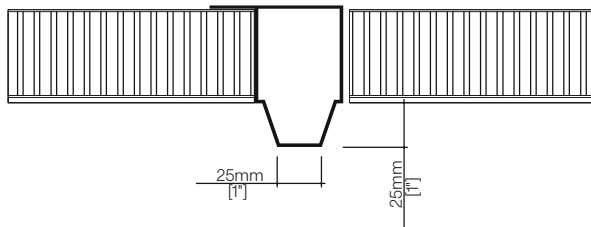
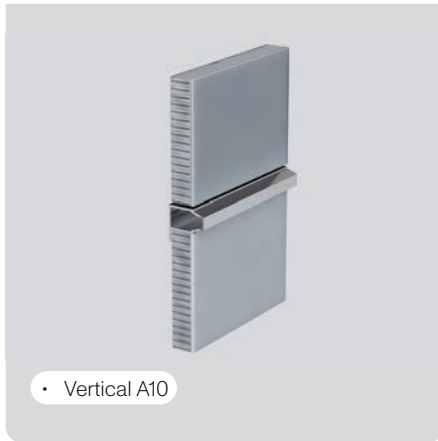

Horizontal

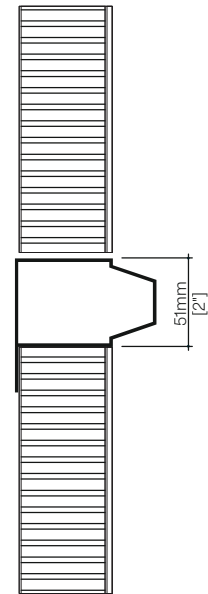

Vertical

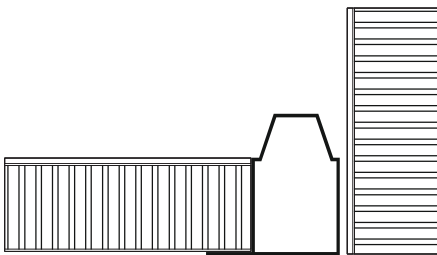

Inner Corner

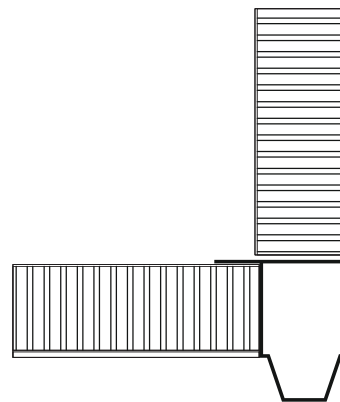

Outer Corner

- 4.20 Face Protruded (A10-P)

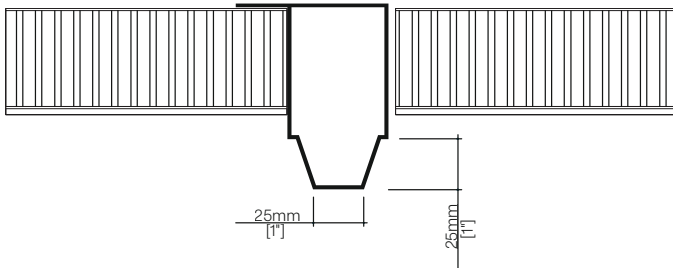
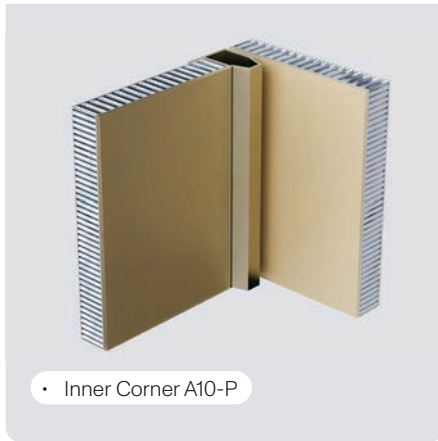

Horizontal

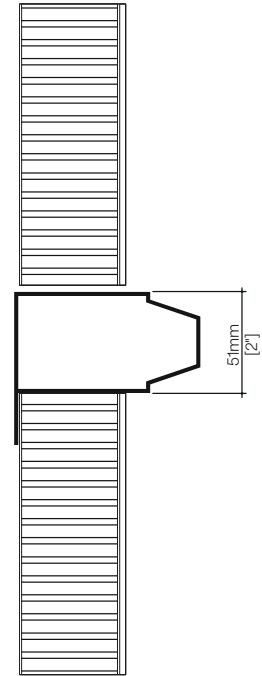

Vertical

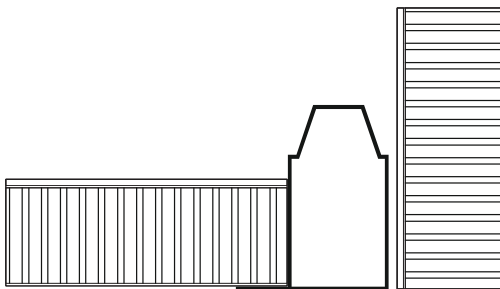

Inner Corner

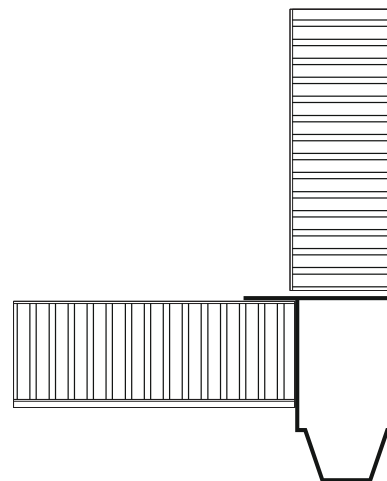

Outer Corner

• 4.21 Face Alignment (A1)

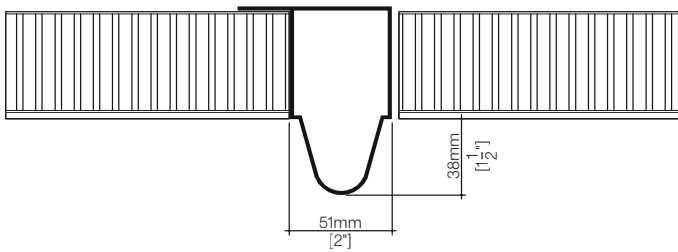
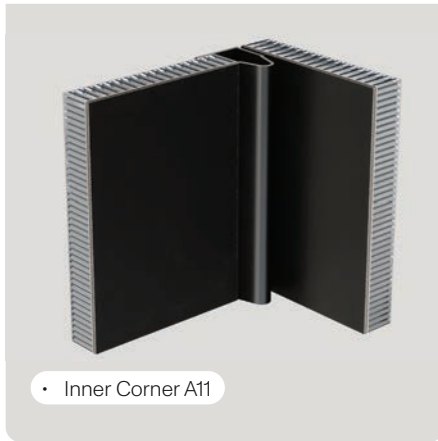

Horizontal

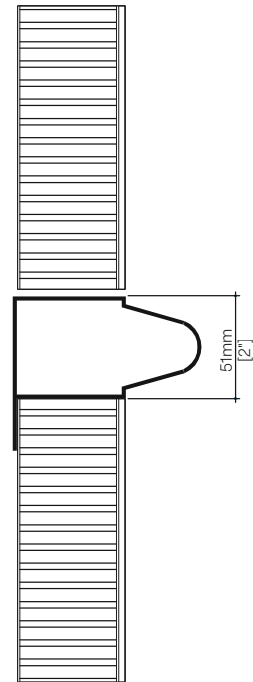

Vertical

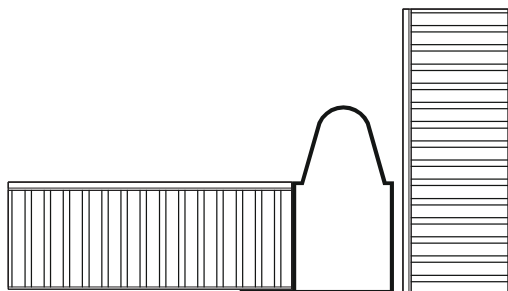

Inner Corner

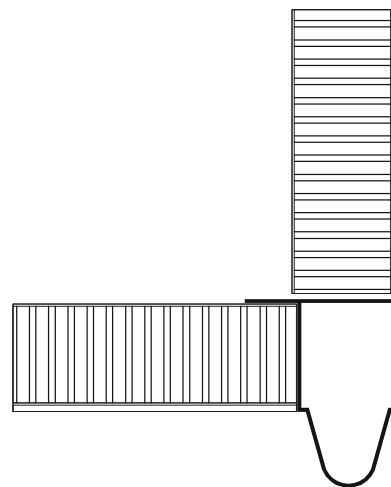

Outer Corner

• 4.22 Face Protruded (A11-P)

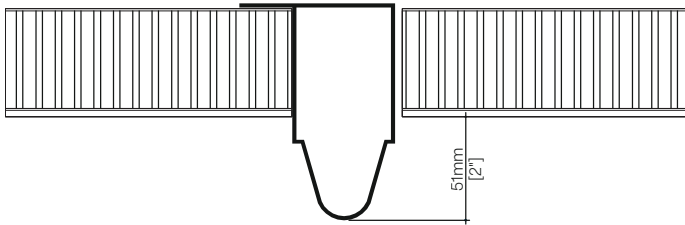

Horizontal

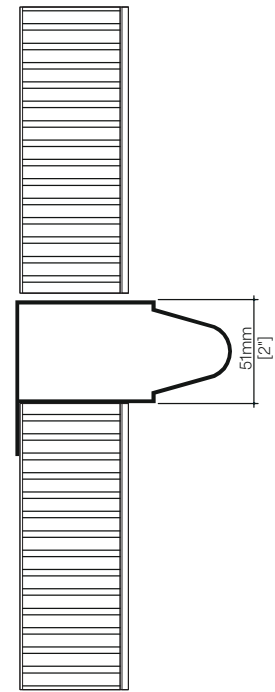

Vertical

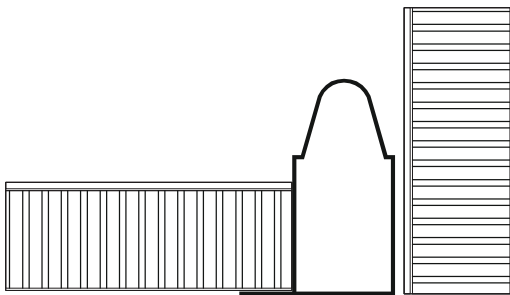

Inner Corner

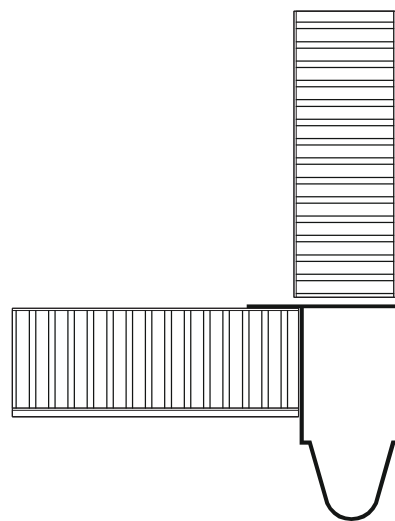

Outer Corner

• 4.23 Face Alignment (A12)

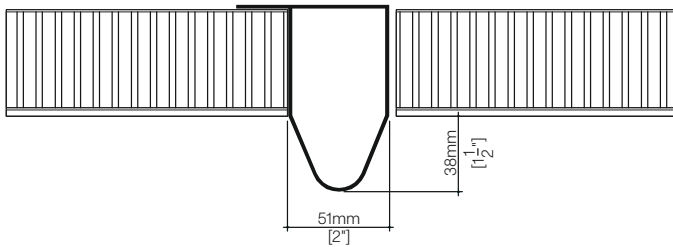
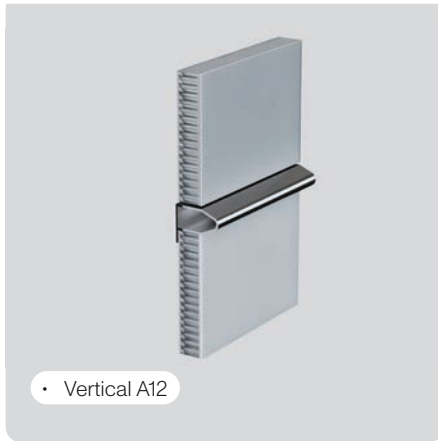

Horizontal

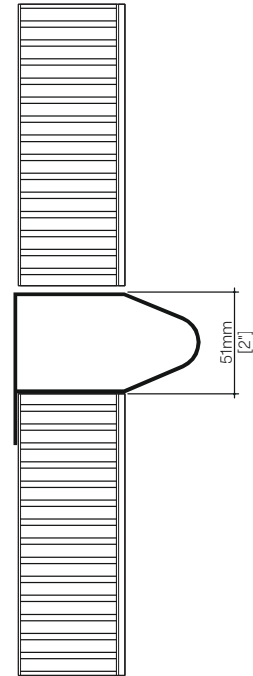

Vertical

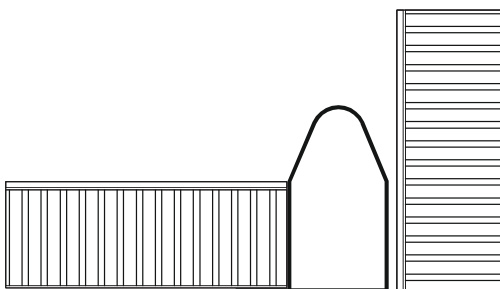

Inner Corner

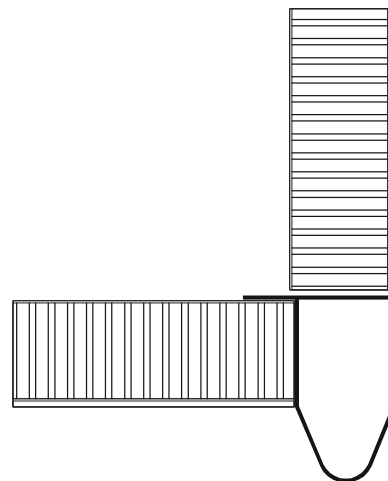

Outer Corner

• 4.24 Face Protruded (A12-P)

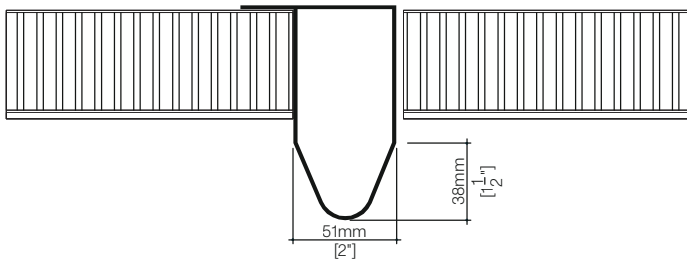

Horizontal

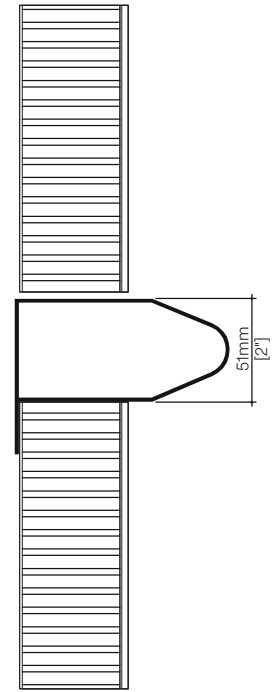

Vertical

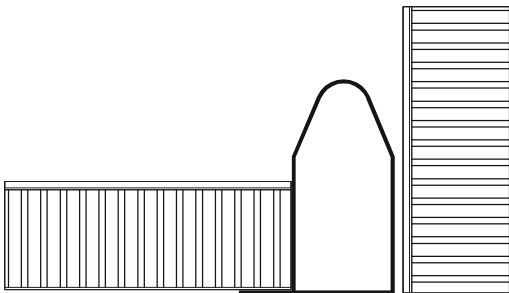

Inner Corner

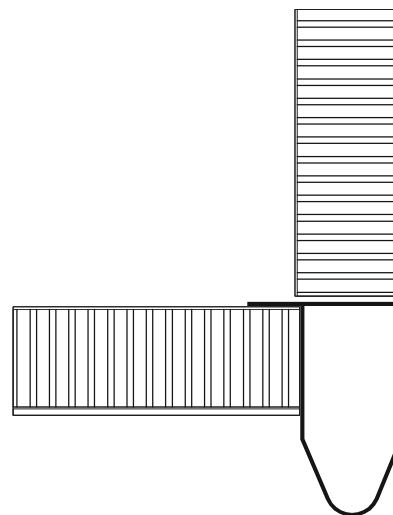

Outer Corner

- 4.25 Face Alignment (A13)

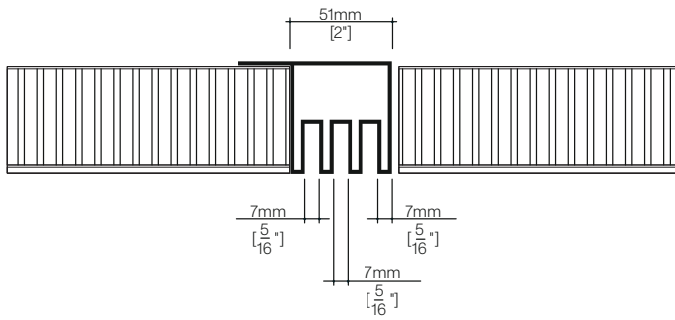
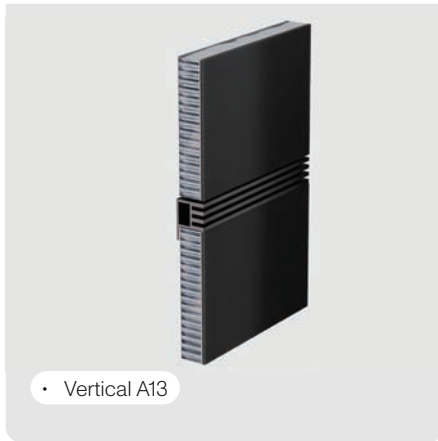

Horizontal

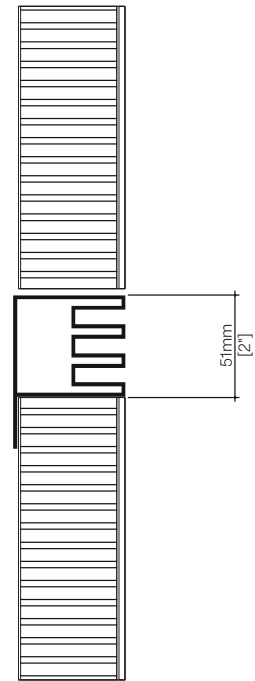

Vertical

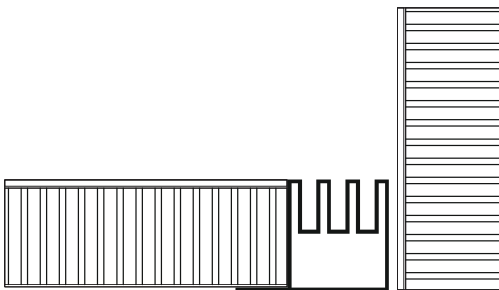

Inner Corner

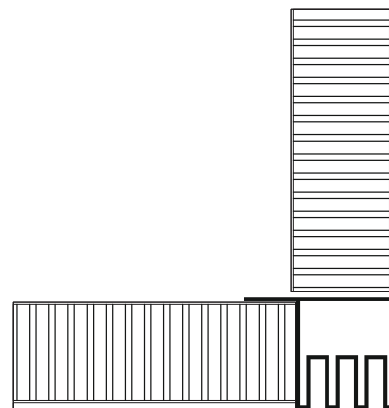

Outer Corner

• 4.26 Face Protruded (A13-P)

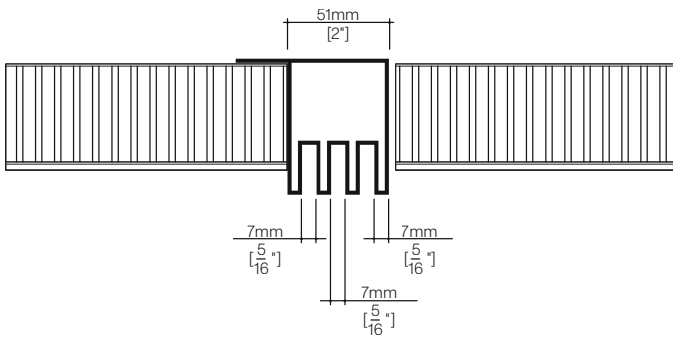
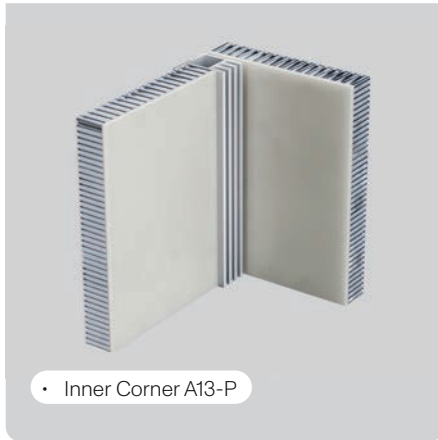

Horizontal

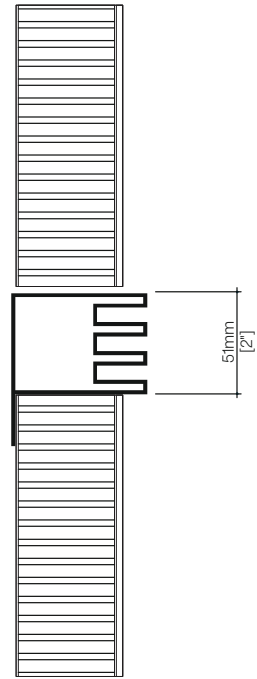

Vertical

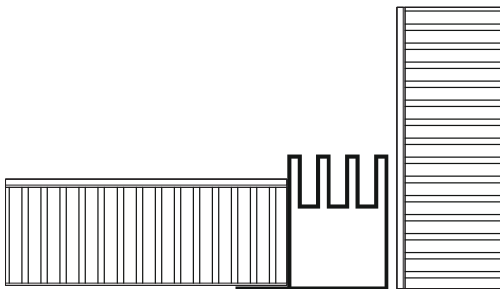

Inner Corner

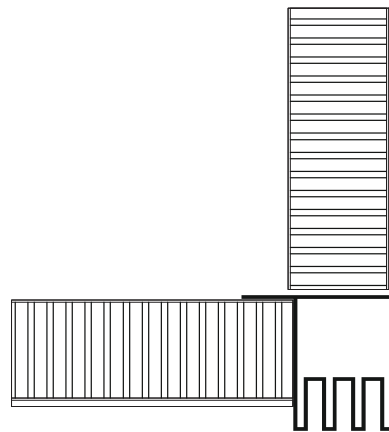

Outer Corner

5. Panel Metal Accents Combinations

With Mitrex solar facades, the transition from our panels to other materials is executed with exceptional care and precision. These termination details are crafted to ensure a flawless integration, where the end of each panel meets alternative materials, like windows, doors, and any other component in a harmonious blend.

Color: Matte, Black, Whit, Brass, Chrome

- 5.1 Face Alignment (A1-A1)

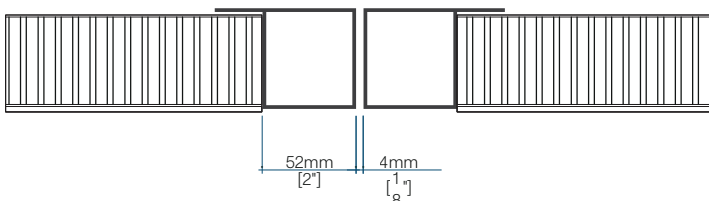

Horizontal

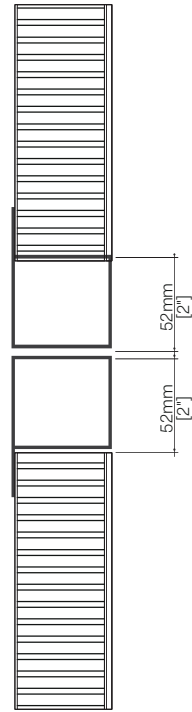

Vertical

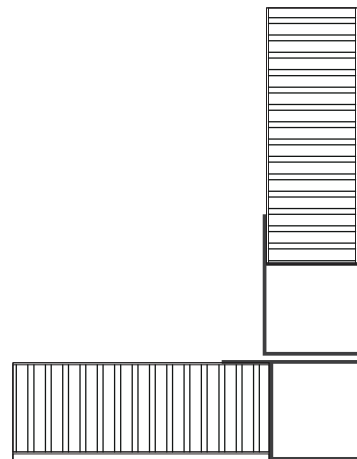

Outer Corner

- 5.2 Face Protruded (A1-P - A1-P)

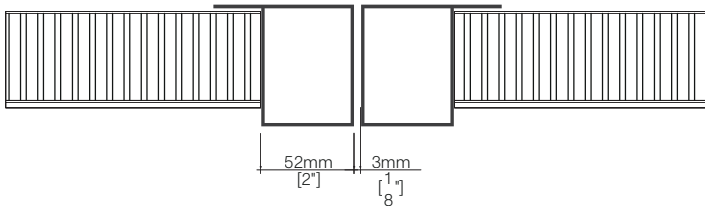
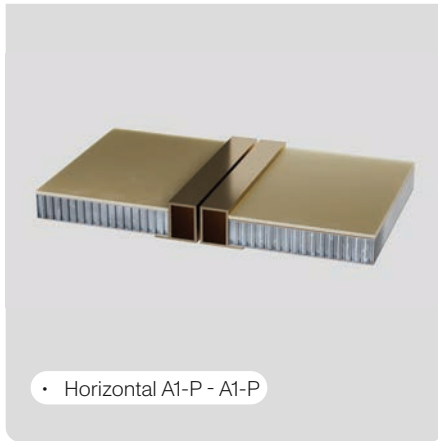

Horizontal

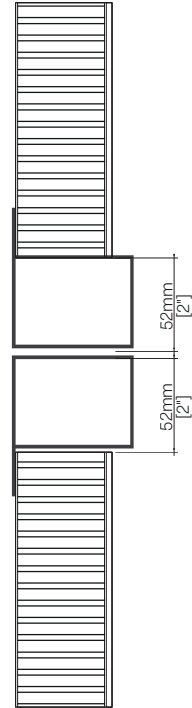

Vertical

• 5.3 Face Alignment (A2-A2)

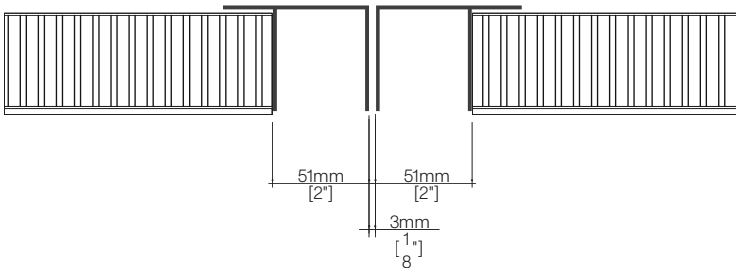
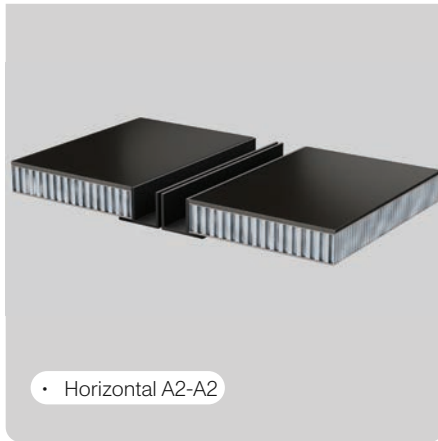

Horizontal

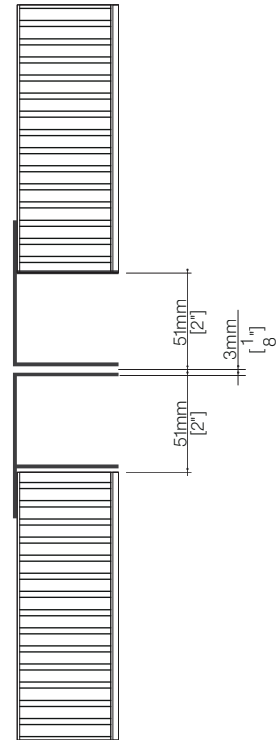

Vertical

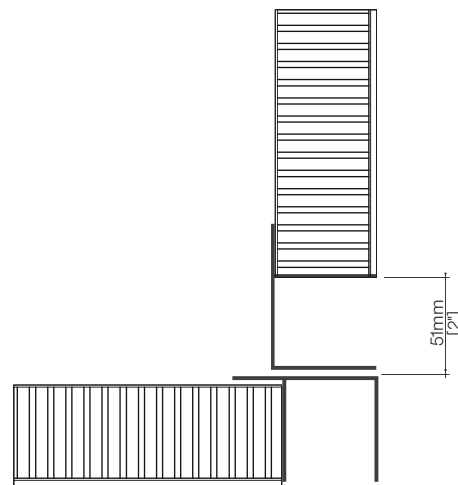

Outer Corner

- 5.4 Face Protruded (A2-P - A2-P)

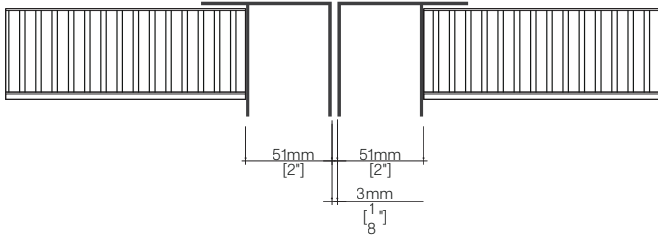

Horizontal

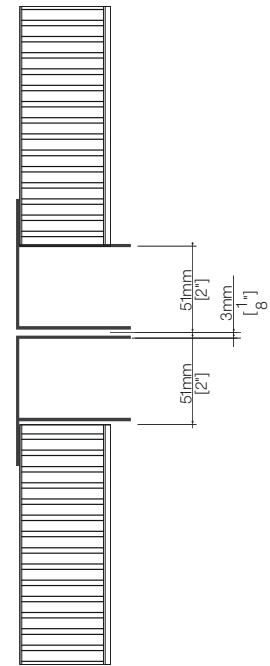

Vertical

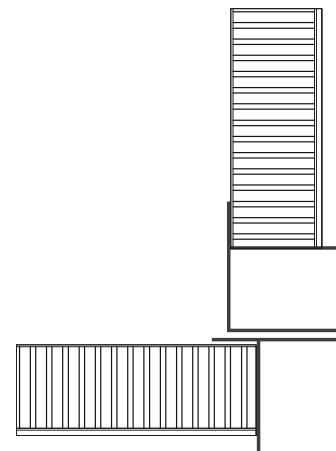

Outer Corner

- 5.5 Face Alignment (A3-A3)

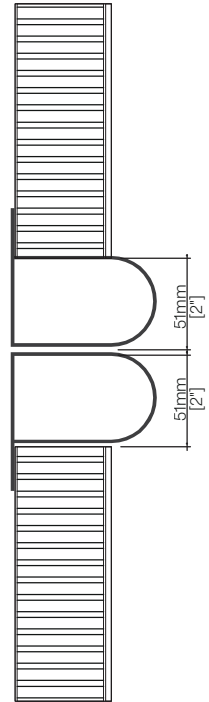
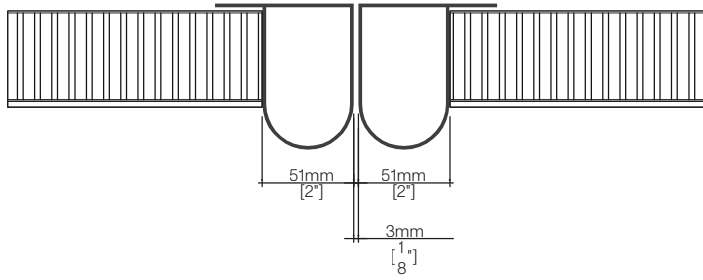

- 5.6 Face Protruded (A3-P - A3-P)

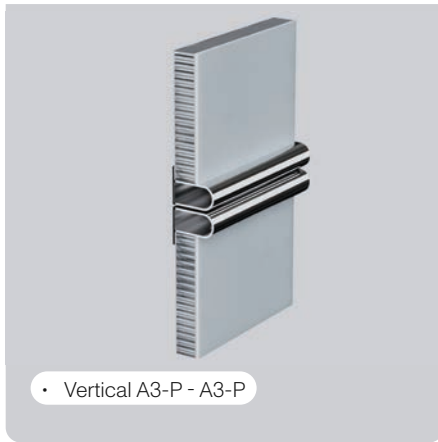

• Vertical A3-P - A3-P

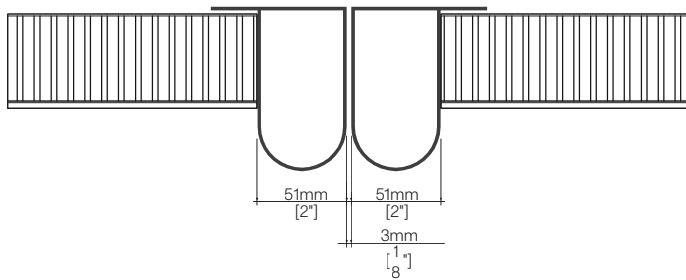

Horizontal

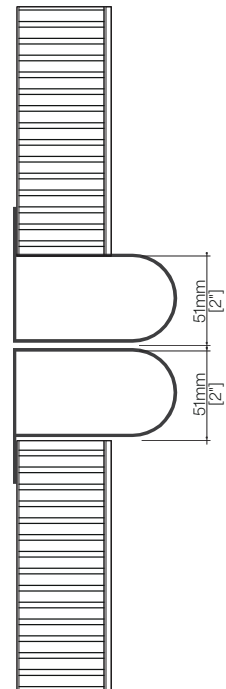

Vertical

- 5.7 Face Alignment (A4-A4)

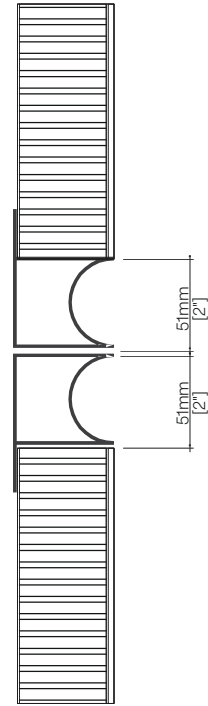
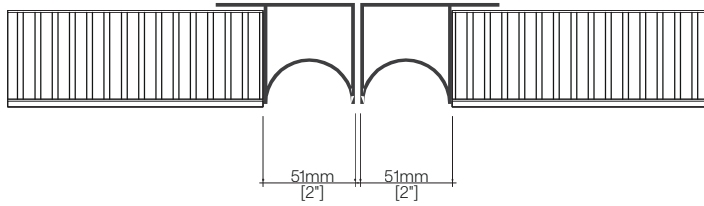

- 5.8 Face Protruded (A4-P - A4-P)

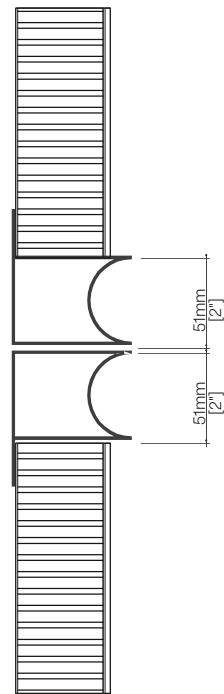
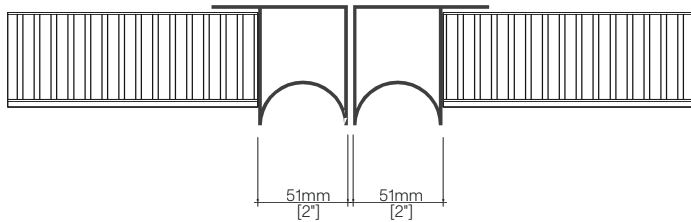
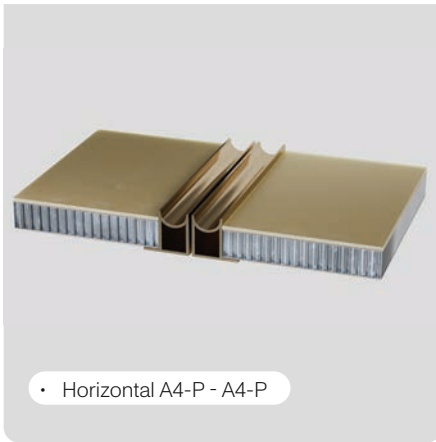

Horizontal

Vertical

- 5.9 Face Alignment (A5-A5)

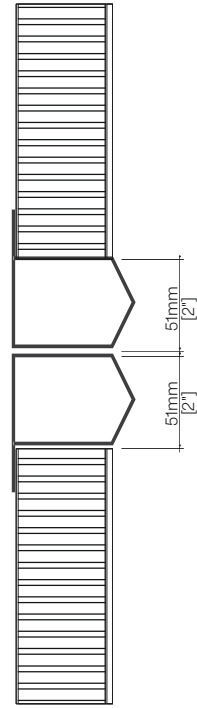
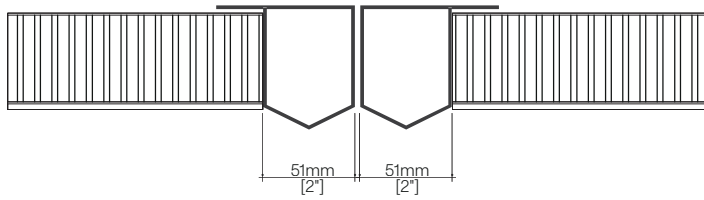

- 5.10 Face Protruded (A5-P - A5-P)

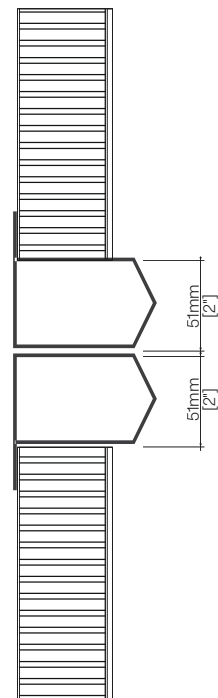
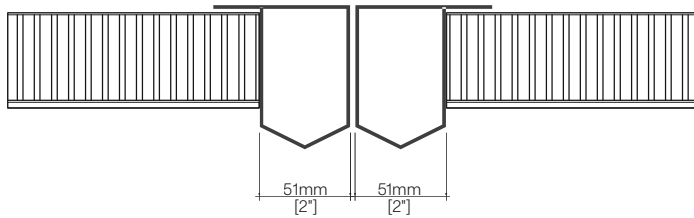

Horizontal

Vertical

- 5.11 Face Alignment (A6-A6)

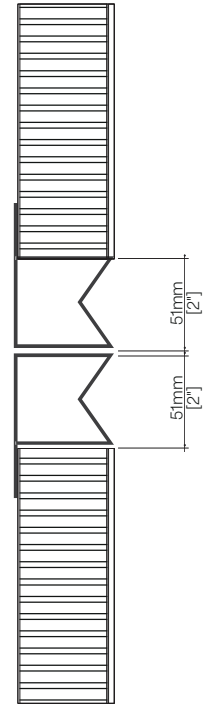
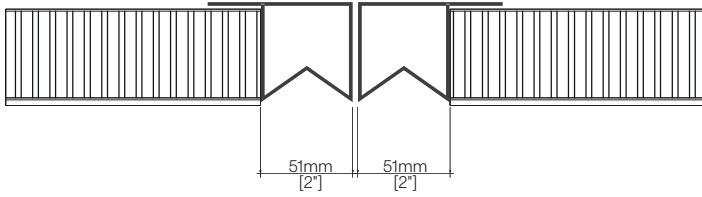

- 5.12 Face Protruded (A6-P - A6-P)

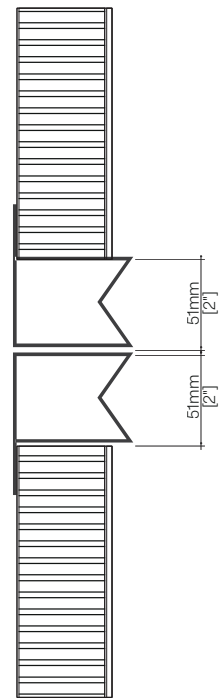
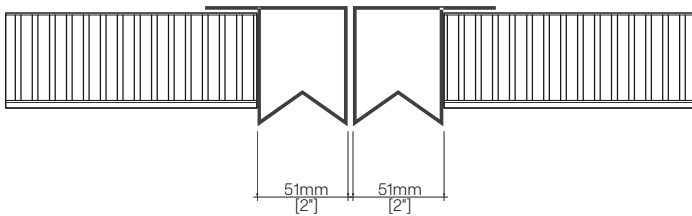
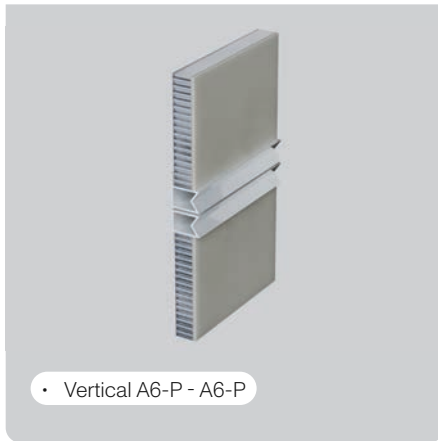

Horizontal

Vertical

- 5.13 Face Alignment (A7-A7)

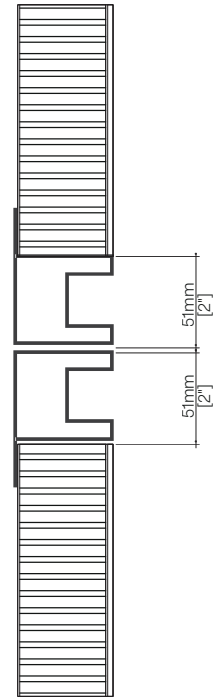
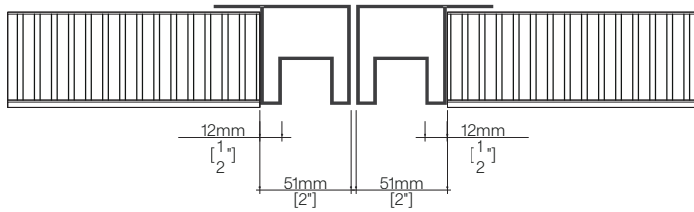

- 5.14 Face Protruded (A7-P - A7-P)

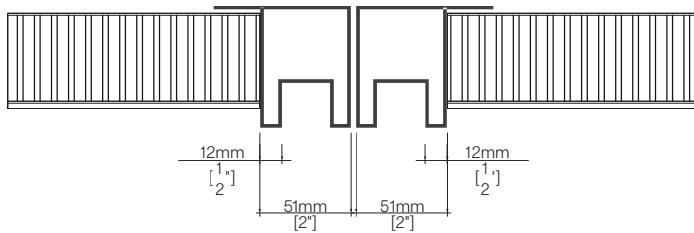

Horizontal

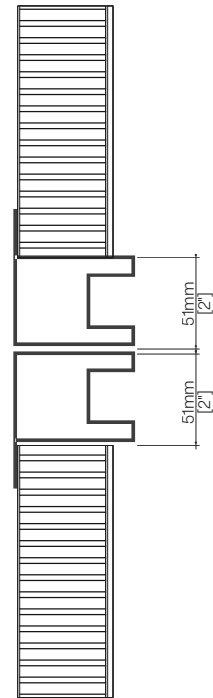

Vertical

- 5.15 Face Alignment (A8-A8)

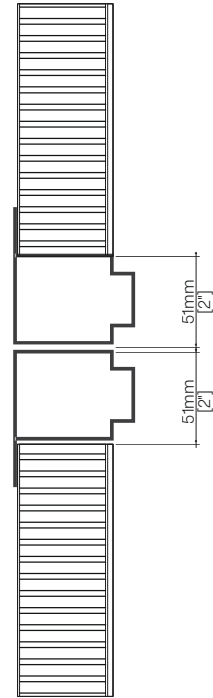
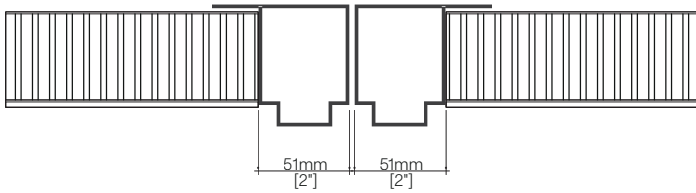
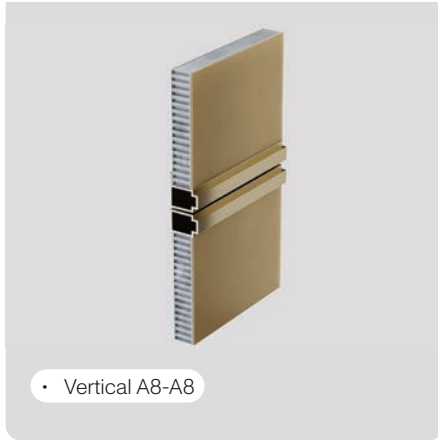

- 5.16 Face Protruded (A8-P - A8-P)

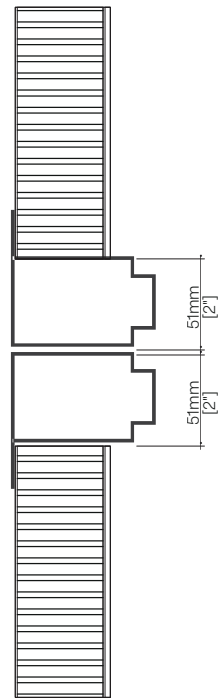
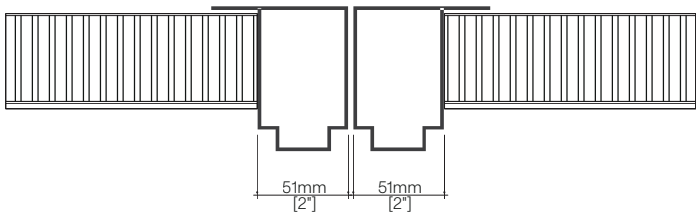

Horizontal

Vertical

- 517 Face Alignment (A9-A9)

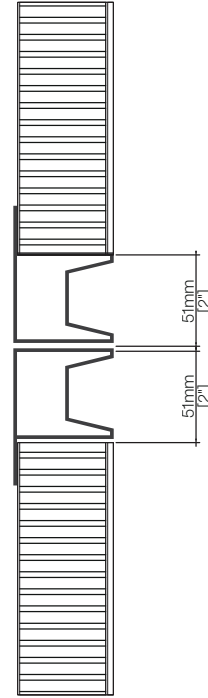
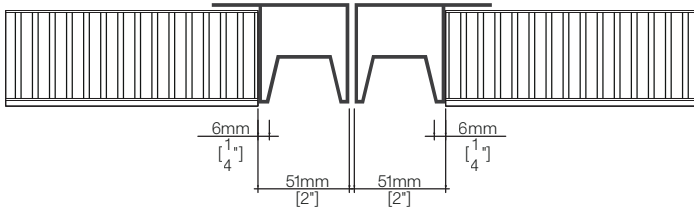
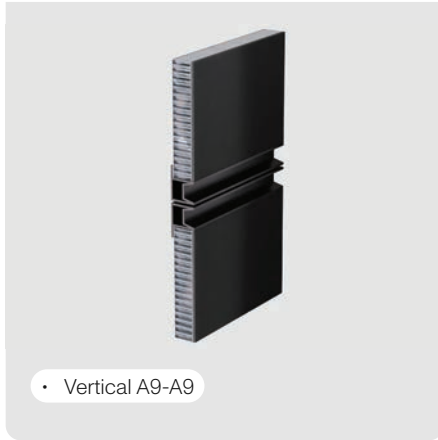

- 518 Face Protruded (A9-P - A9-P)

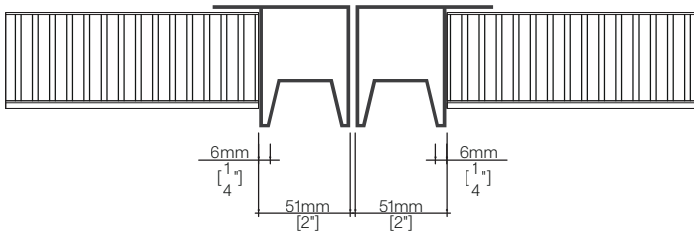

Horizontal

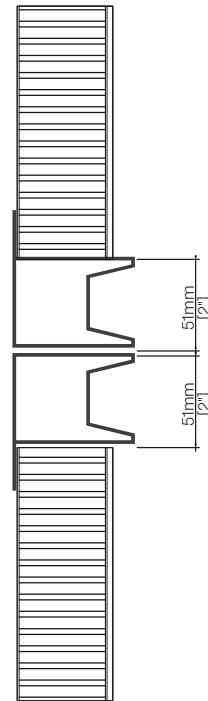

Vertical

- 5.19 Face Alignment (A10-A10)

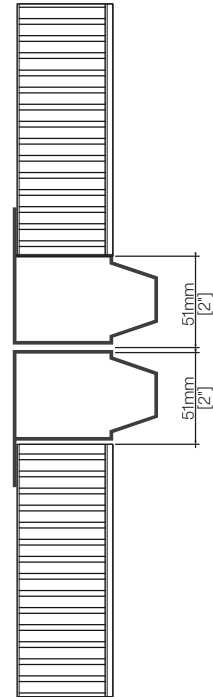
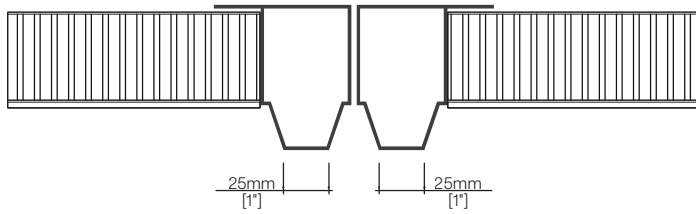
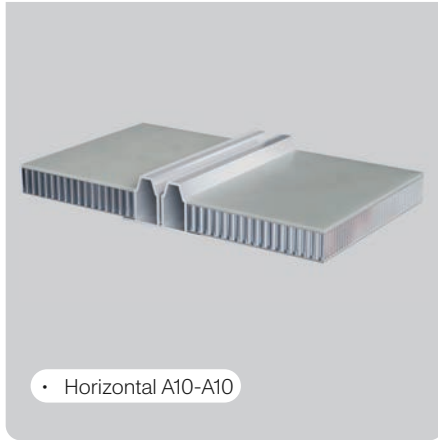

- 5.20 Face Protruded (A10-P - A10-P)

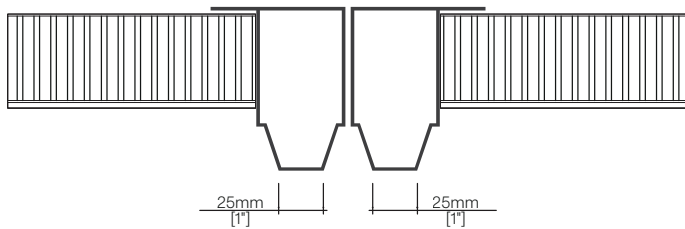

Horizontal

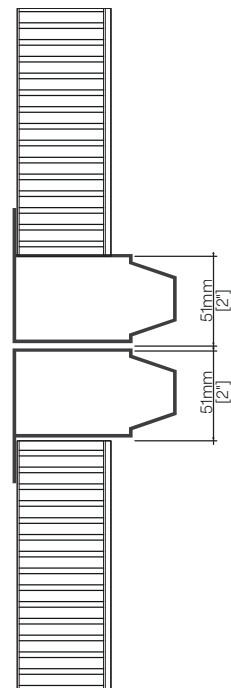

Vertical

- 5.21 Face Alignment (A11-A11)

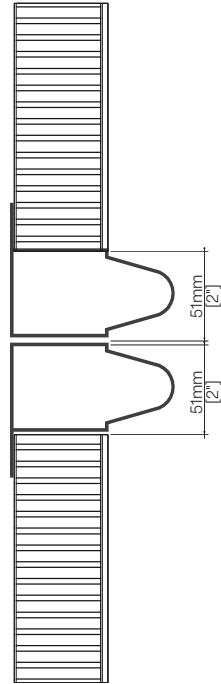
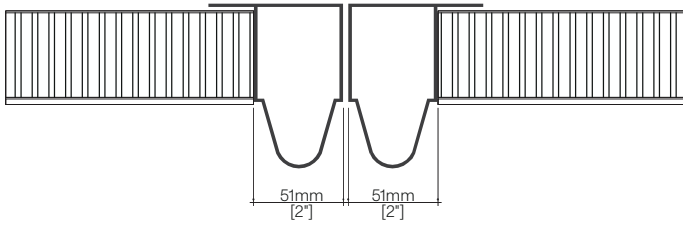
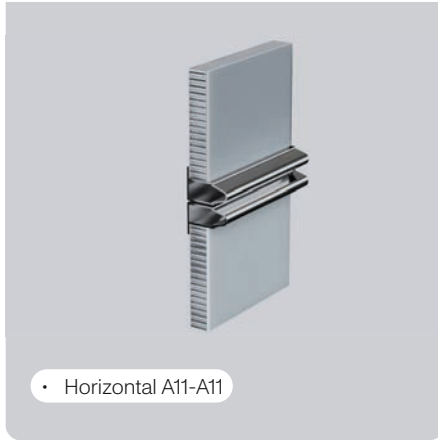

- 5.22 Face Protruded (A11-P - A11-P)

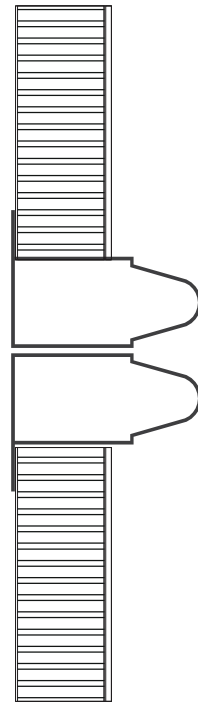
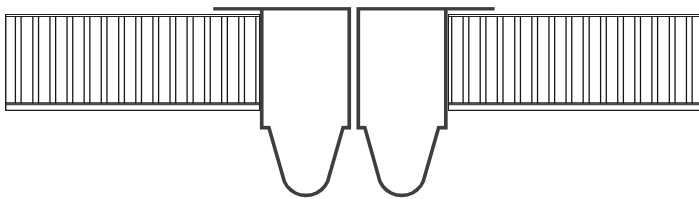

• 5.23 Face Alignment (A12-A12)

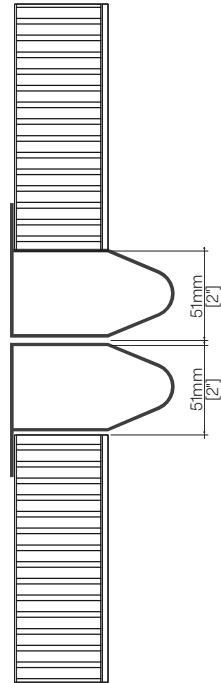
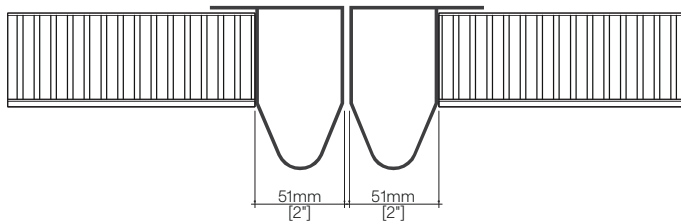
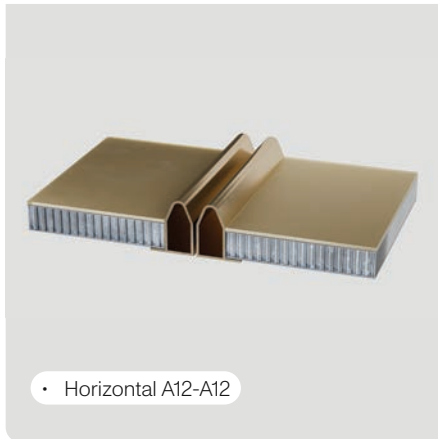

• 5.24 Face Protruded (A12-P - A12-P)

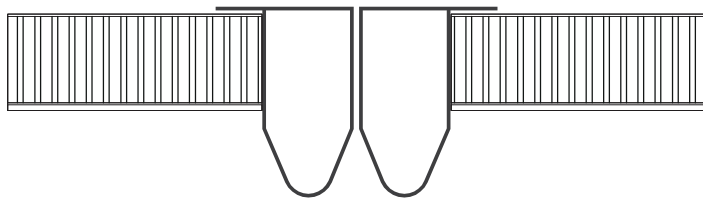

Horizontal

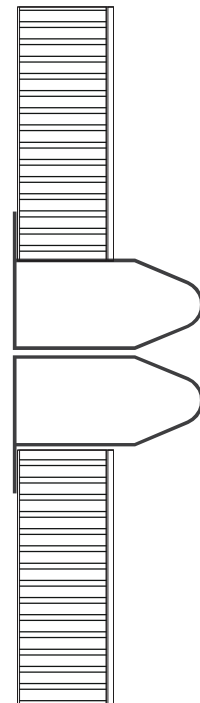

Vertical

• 5.25 Face Alignment (A13-A13)

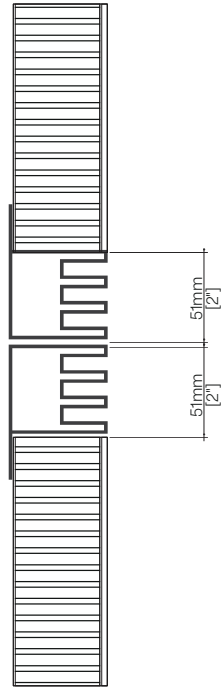
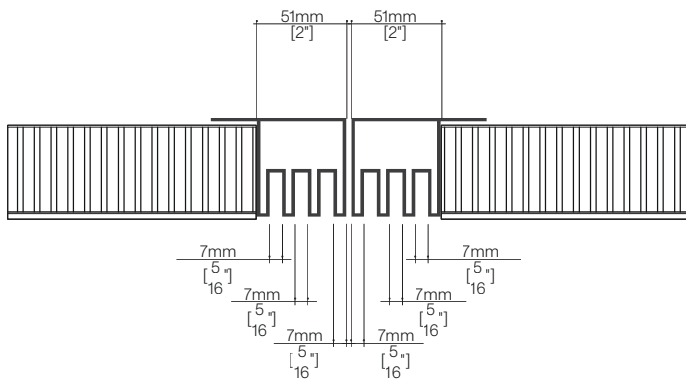

• 5.26 Face Protruded (A13-P - A13-P)

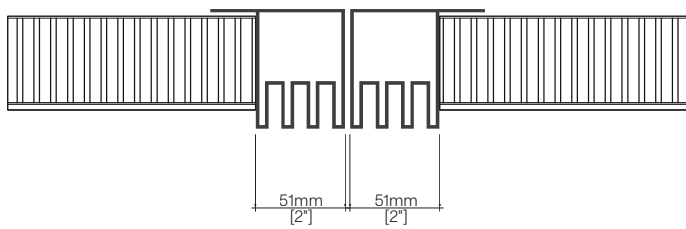
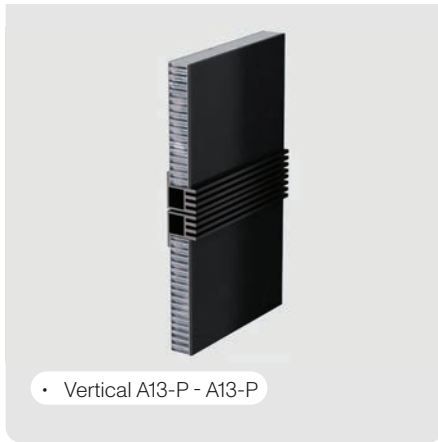

Horizontal

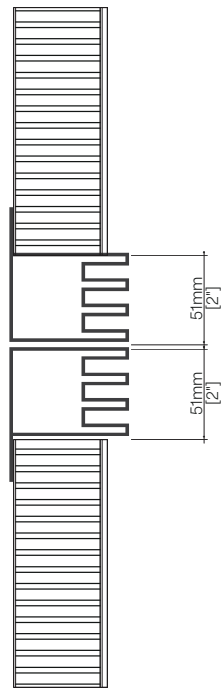

Vertical

• 5.27 Face Alignment And Protruded (A1-A1-P)

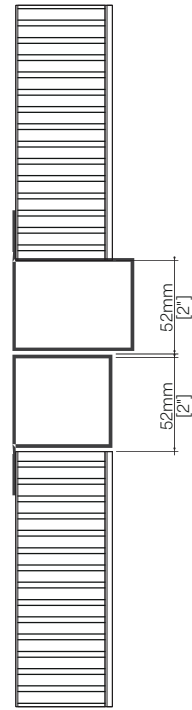
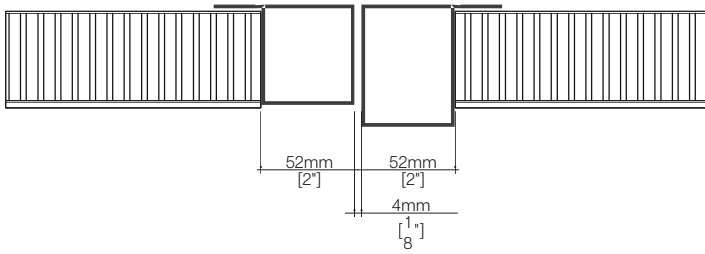
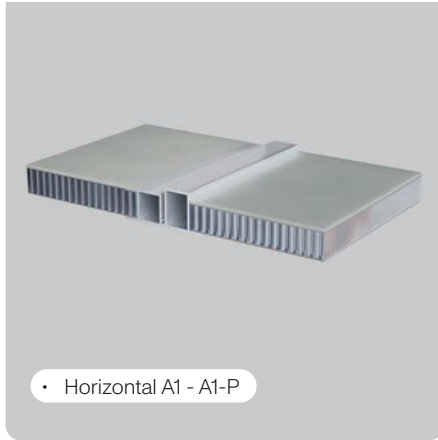

• 5.28 Face Alignment And Protruded (A3 - A3-P)

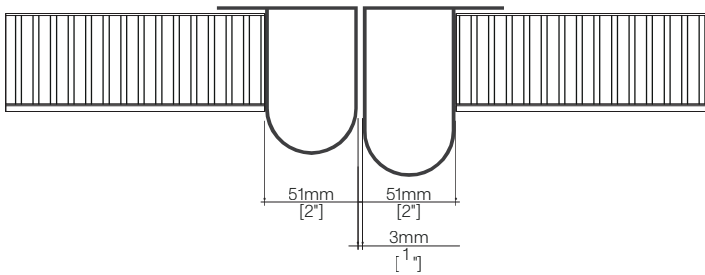

Horizontal

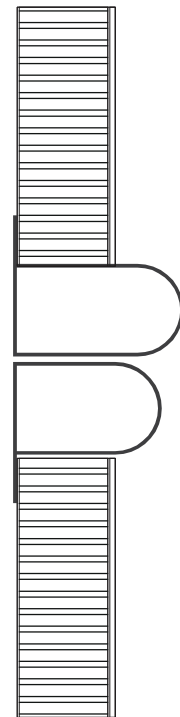

• 5.29 Face Alignment And Protruded (A4 - A4-P)

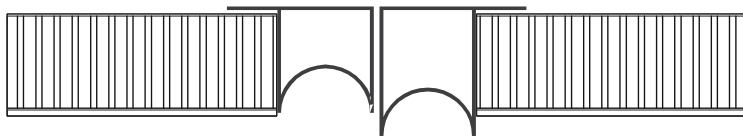
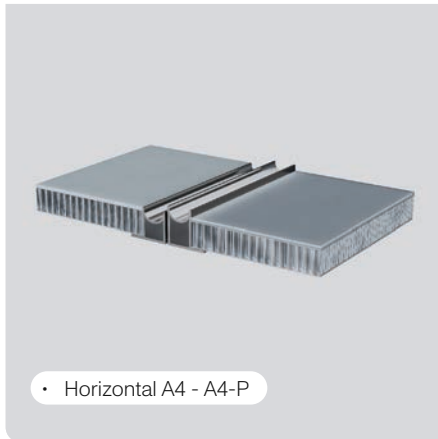

• 5.30 Face Alignment And Protruded (A5 - A5-P)

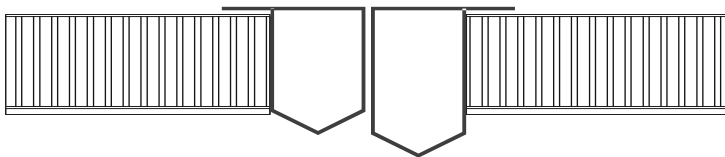

Horizontal

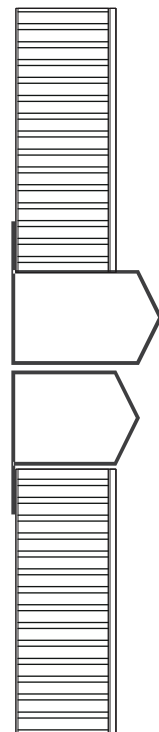

Vertical

- 5.31 Face Alignment And Protruded (A7-A7-P)

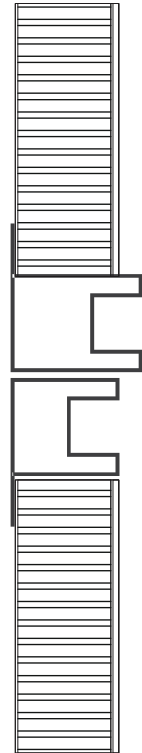
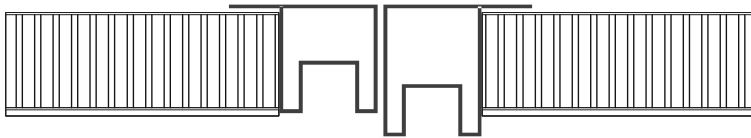
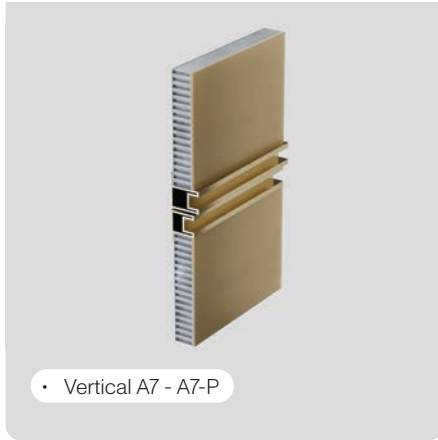

- 5.32 Face Alignment And Protruded (A9 - A9-P)

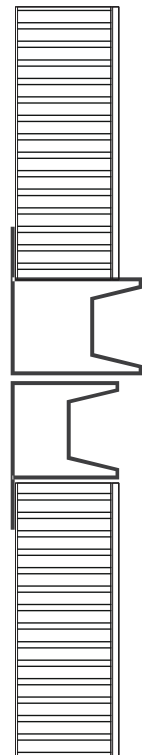

Horizontal

Vertical

• 5.33 Face Alignment And Protruded (A8 - A8-P)

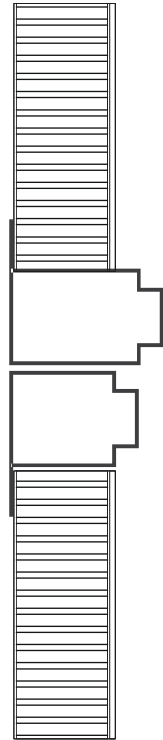
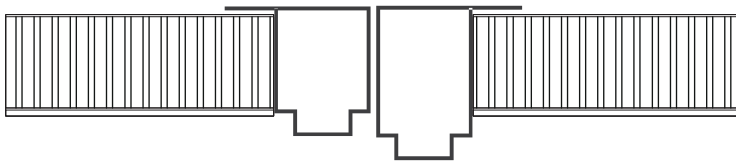

• 5.34 Face Alignment And Protruded (A10 - A10-P)

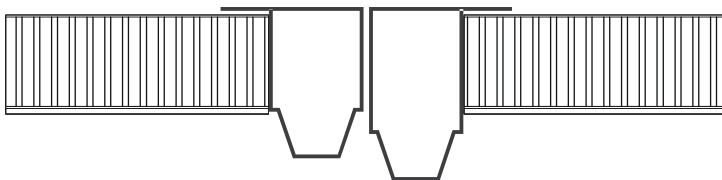

Horizontal

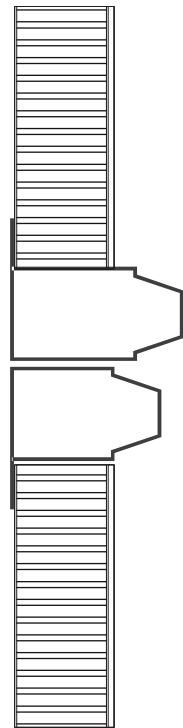

Vertical

- 5.35 Face Alignment And Protruded (A11 - A11-P)

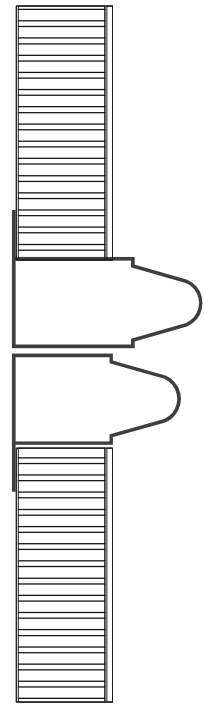
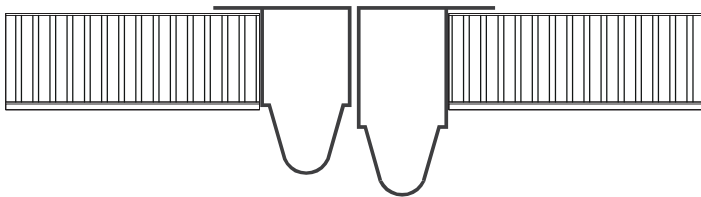
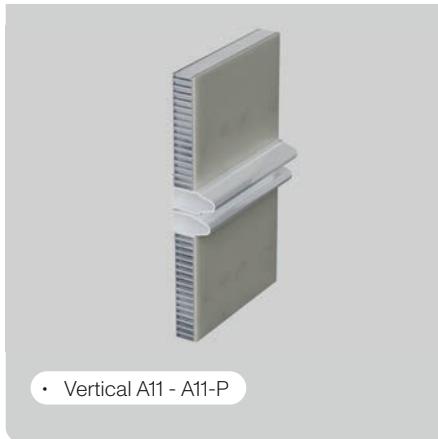

- 5.36 Face Alignment And Protruded (A13 - A13-P)

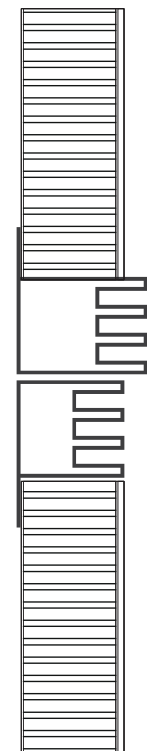

Horizontal

Vertical

- 5.37 Face Alignment And Protruded (A12 - A12-P)

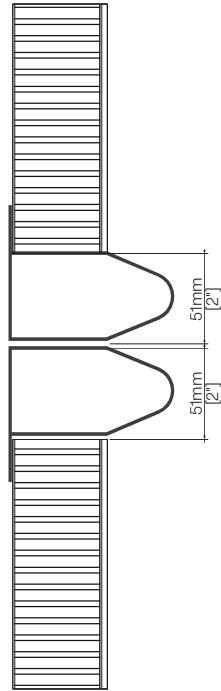
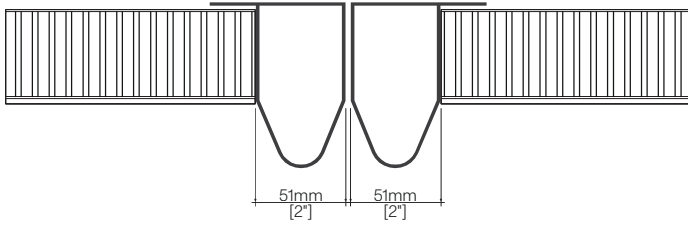

- 5.38 Face Alignment (A1 - A2)



- 5.39 Face Protruded (A1-P - A2-P)



Horizontal

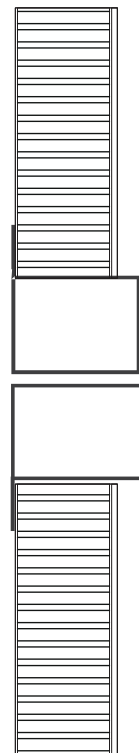

Vertical

- 5.40 Face Alignment (A3 - A4)

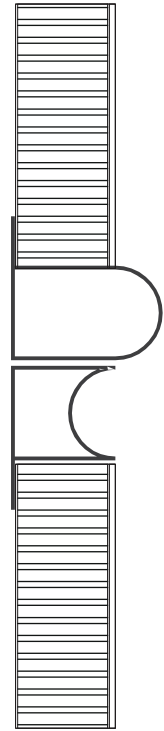

- 5.41 Face Protruded (A3-P - A4-P)

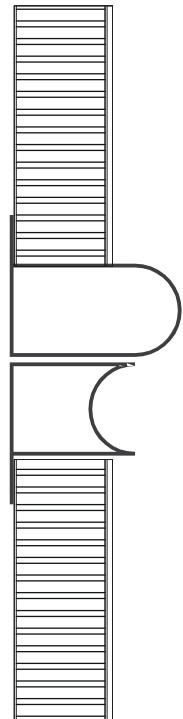

Horizontal

Vertical

- 5.42 Face Alignment (A5 - A6)

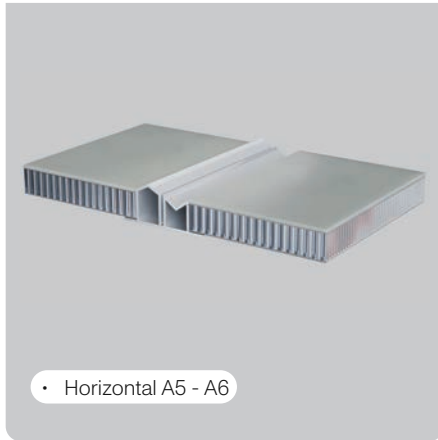

- 5.43 Face Protruded (A5-P - A6-P)

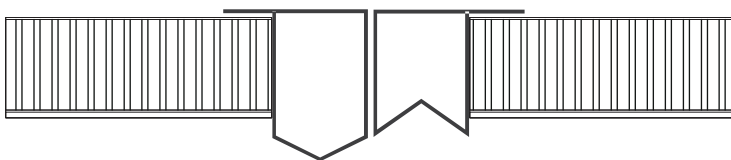

Horizontal

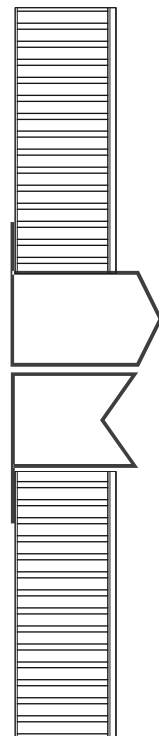

Vertical

- 5.44 Face Alignment (A7 - A8)

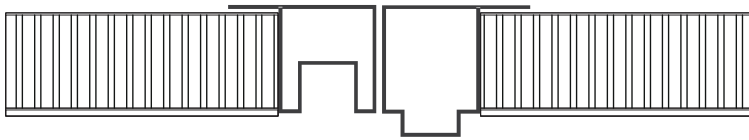

- 5.45 Face Protruded (A7-P - A8-P)

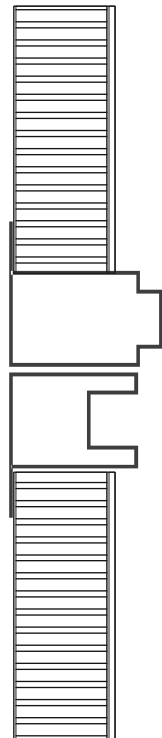
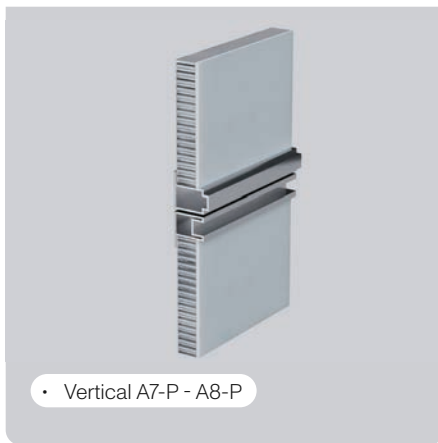

Horizontal

Vertical

- 5.46 Face Alignment (A9 - A10)

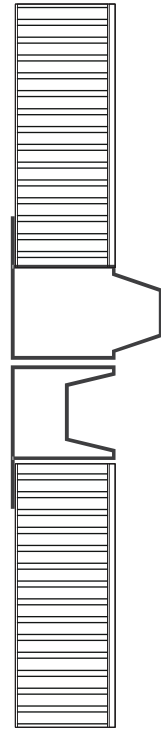
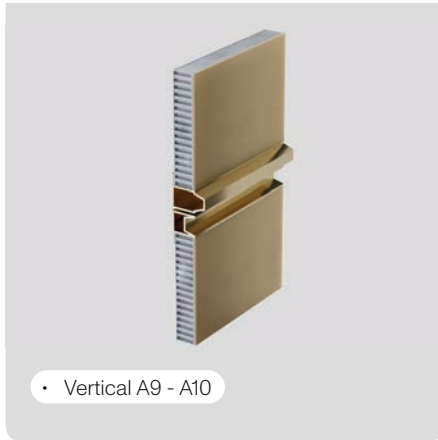

- Face Protruded (A9-P - A10-P)

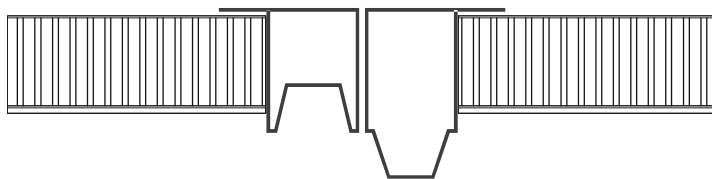

Horizontal

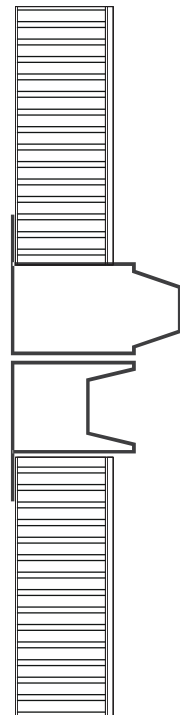

Vertical

- **Toll Free**

+1 (855) 254 0214

- **Learn More**

mitrex.com

info@mitrex.com

- **Headquarters**

41 Racine Rd, Toronto, ON M9W2Z4, Canada

+1 (416) 497 7120

- **USA Office**

Chrysler Building, 405 Lexington Avenue Floor 26, New York, USA, 10174

+1 (646) 583 4486